

GUIDELINES FOR THE EVALUATION OF UNDERGROUND STORAGE TANK CATHODIC PROTECTION SYSTEMS



**MISSISSIPPI DEPARTMENT OF ENVIRONMENTAL QUALITY
OFFICE OF POLLUTION CONTROL
UNDERGROUND STORAGE TANK BRANCH
P.O. BOX 2261
JACKSON, MS 39225-2261
TELEPHONE: (601) 961-5171
FACSIMILE: (601) 961-5093**

www.deq.state.ms.us

JULY 1, 2002

TABLE OF CONTENTS

SECTION 1 – GENERAL

1.1	Introduction	1
-----	--------------------	---

SECTION 2 – REGULATIONS

2.1	Rules	2
-----	-------------	---

SECTION 3 – TYPES OF CATHODIC PROTECTION

3.1	General	4
3.2	Galvanic Systems	4
3.3	Impressed Current Systems	4

SECTION 4 – QUALIFICATIONS TO TEST CATHODIC PROTECTION SYSTEMS

4.1	Qualifications	5
-----	----------------------	---

SECTION 5 – INSTALLATION/REPAIR OF CATHODIC PROTECTION SYSTEMS

5.1	Galvanic Systems	6
5.1.1	sti-P ₃ [®] Tanks	6
5.1.2	Factory Coated Metallic Piping	6
5.1.3	Non-factory Coated Metallic Piping	6
5.1.4	Metallic Piping Installation/Repair	6
5.2	Impressed Current Systems	8
5.2.1	Rectifier Adjustment	8

SECTION 6 – CATHODIC PROTECTION TESTING

6.1	Equipment	9
6.1.1	Voltmeter/Ammeter	9
6.1.2	Reference Electrode	10
6.1.3	Lead Wires/Test Probes/Miscellaneous	11
6.2	Test Criteria	12
6.3	Voltage (IR) Drops	13
6.4	Stray Current	14
6.5	Dissimilar Metals/Bimetallic Couples	15
6.6	Other Test Considerations	16
6.7	Continuity Testing	18
6.7.1	Continuity Testing of Galvanic Systems	19
6.7.2	Continuity Testing of Impressed Current Systems	19
6.8	Reference Electrode Placement	19
6.8.1	General	19
6.8.2	Local Placement	19
6.8.3	Remote Placement	20
6.8.4	Galvanic Placement	20
6.8.5	Impressed Current Placement	21
6.9	Soil Access	21
6.10	Cathodic Protection Test Locations	22
6.10.1	Galvanically Protected (sti-P ₃ [®]) Tanks	22
6.10.2	Galvanically Protected Metallic Piping	23
6.10.3	Tanks Protected by Impressed Current	25
6.10.4	Piping Protected by Impressed Current	26
6.10.5	“100 Foot Rule” for Piping	27

SECTION 7 – DOCUMENTATION OF EVALUATION

7.1	Documentation	28
7.1.1	As Built Drawings	28
7.1.2	Site Drawing	28
7.1.3	MDEQ UST Cathodic Protection Evaluation Form	29
7.1.4	Pass/Fail/Inconclusive	30
7.2	Corrosion Expert’s Evaluation	30
7.3	What if the Evaluation Result is Fail?	31

LIST OF FIGURES

FIGURE 1	ILLUSTRATION OF REFERENCE ELECTRODE CALIBRATION	11
FIGURE 2	GRAPHIC REPRESENTATION OF VOLTAGE DROP IN "ON" POTENTIAL	13
FIGURE 3	LOCAL REFERENCE ELECTRODE PLACEMENT FOR sti-P ₃ [®] TANKS	22
FIGURE 4	REMOTE EARTH REFERENCE ELECTRODE PLACEMENT	23
FIGURE 5	LOCAL REFERENCE ELECTRODE PLACEMENT FOR GALVANICALLY PROTECTED PIPING WHEN PIPING ANODES ARE AT TANKS	23
FIGURE 6	LOCAL REFERENCE ELECTRODE PLACEMENT FOR GALVANICALLY PROTECTED PIPING WHEN PIPING ANODES ARE AT DISPENSERS	24
FIGURE 7	LOCAL REFERENCE ELECTRODE PLACEMENT FOR GALVANICALLY PROTECTED PIPING WHEN PIPING ANODES ARE AT BOTH ENDS OF THE PIPING	24
FIGURE 8	LOCAL REFERENCE ELECTRODE PLACEMENT FOR GALVANICALLY PROTECTED PIPING WHEN ANODES ARE INSTALLED AT CENTER OF PIPING OR LOCATION IS UNKNOWN	25
FIGURE 9	REFERENCE ELECTRODE PLACEMENT FOR TANKS PROTECTED BY IMPRESSED CURRENT SYSTEM WHEN ANODES ARE EVENLY DISTRIBUTED	25
FIGURE 10	REFERENCE ELECTRODE PLACEMENT FOR TANKS PROTECTED BY IMPRESSED CURRENT SYSTEM WHEN ANODES ARE UNEVENLY DISTRIBUTED	26
FIGURE 11	REFERENCE ELECTRODE PLACEMENT FOR METALLIC PIPING PROTECTED BY IMPRESSED CURRENT SYSTEM	27
FIGURE 12	"100 FOOT RULE" FOR METALLIC PIPING PROTECTED BY GALVANIC OR IMPRESSED CURRENT SYSTEM	27
FIGURE 13	EXAMPLE OF A SITE DRAWING CONSTRUCTED AS PART OF A UST SYSTEM CATHODIC PROTECTION SURVEY	29

APPENDICES

APPENDIX A	Industry Codes/Standards, References and Regulations
APPENDIX B	Glossary
APPENDIX C	Interpretation of Structure-to-Soil Potential Measurements (Voltages) Obtained on Galvanic Cathodic Protection Systems
APPENDIX D	Interpretation of Structure-to-Soil Potential Measurements (Voltages) Obtained on Impressed Current Cathodic Protection Systems
APPENDIX E	Continuity Testing Procedure for Galvanic/Impressed Current Systems
APPENDIX F	Structure-to-Soil Test Procedure for Galvanic Cathodic Protection Systems
APPENDIX G	Structure-to-Soil Test Procedure for Impressed Current Cathodic Protection Systems
APPENDIX H	Checklist for Galvanic Cathodic Protection System Survey
APPENDIX I	Checklist for Impressed Current Cathodic Protection System Survey
APPENDIX J	Typical Potentials of Selected Metals
APPENDIX K	Galvanic (Sacrificial Anode) Cathodic Protection System Evaluation Form
APPENDIX L	Impressed Current Cathodic Protection System Evaluation Form
APPENDIX M	Impressed Current Cathodic Protection System 60 Day Record of Rectifier Operation

SECTION 1 – GENERAL

1.1 Introduction

The purpose of this document is to establish the policy of this office regarding the evaluation of cathodic protection systems operating on underground storage tank (UST) systems in the State of Mississippi. While conducting structure-to-soil potential surveys is the primary means of testing cathodic protection systems, other aspects related to the evaluation, installation, operation and repair of cathodic protection systems are also addressed in this document where necessary.

Evaluation of cathodic protection systems to ensure they are functioning as intended has proven to be one of the more problematic areas that has led to a great deal of confusion and various practices among individuals engaged in the field of cathodic protection. Because the applicable regulations contain no specific criteria and instead defer to industry standards, a large degree of latitude has historically been provided for interpretation of what constitutes an acceptable evaluation.

Since there are many factors that can affect cathodic protection, there is understandably no standard test method or “cookie-cutter” approach that will work at every site that has a cathodic protection system in operation. Therefore, the primary intent of this policy is to create a level playing field in which everyone engaged in the field of UST system cathodic protection in the State of Mississippi understands what is expected. The second focus of this policy is to provide that documentation sufficient to reproduce the results generated by a cathodic protection tester must be established in order to conduct a valid cathodic protection evaluation. To this end, forms that must be utilized when evaluating cathodic protection are included in Appendix K and L of this document.

It is further necessary to understand that the creation of this policy has necessitated a compromise to some degree. Every effort has been made so as not to place an unduly harsh burden on the tank owners and contractors who operate in the State of Mississippi. At the same time, it is necessary to be protective of human health and the environment to the degree required to achieve the charge of the Mississippi Department of Environmental Quality (MDEQ). This document represents the best efforts of the MDEQ to assure that cathodic protection systems operate as intended and effectively mitigate corrosion while being mindful of the economic constraints that must be considered.

Some of the more important points established with this guidance document are:

- Access to the soil directly over the structure that is being tested must be provided.
- Both “local” and “remote” structure-to-soil potentials must be obtained on galvanic systems.
- “Instant off” potentials must be obtained on all impressed current systems.
- Continuity/isolation must be established whenever a cathodic protection survey is conducted.
- Under certain conditions a “corrosion expert” must evaluate the cathodic protection survey.
- A person must meet certain minimum qualifications in order to conduct an effective evaluation.

Simply conducting a structure-to-soil potential survey does not adequately evaluate a cathodic protection system. Other considerations that may need to be addressed are outlined in the text of this document and include: continuity measurements; evaluation of rectifier operation; current distribution among an impressed current anode ground bed; consideration of voltage drops; assurance of wiring integrity; continuity bonds; as built drawings and others.

This policy is not intended to replace any statute or regulatory requirement concerning the installation, repair, operation or testing of cathodic protection systems. Rather, it is intended to state the interpretation of the MDEQ with regard to the implementation of those rules and regulations applicable to UST cathodic protection systems.

SECTION 2 - REGULATIONS

2.1 Rules

Federal and state laws require that any component of a UST system that routinely contains product and is in contact with the soil must be protected from corrosion. If the UST component in question is of metallic construction and it is in contact with the soil and/or water, it must be cathodically protected. If it is cathodically protected it must also be coated with a suitable dielectric material if the metallic component in question was installed after December 22, 1988.

The rules also require that all cathodic protection systems must be evaluated within six months of installation/repair and once every three years thereafter. Consideration should be given to evaluating impressed current systems on an annual basis since these types of systems are more susceptible to failure or may be in need of adjustment on a more frequent basis in order to provide adequate cathodic protection.

The MDEQ adopted verbatim the federal UST rules found under Subtitle I of the Resource Conservation and Recovery Act. The rules are published in Chapter 40 Part 280 of the Code of Federal Regulation ("Technical Standards and Corrective Action Requirements for Owners and Operators of Underground Storage Tank Systems"). The regulations reference several industry codes and practices and a listing of these may be found in Appendix A of this document. Following are the pertinent paragraphs of 40 CFR 280 that are related to cathodic protection:

280.12 Definitions

"Cathodic Protection" is a technique to prevent corrosion of a metal surface by making that surface the cathode of an electrochemical cell. For example, a tank system can be cathodically protected through the application of either galvanic anodes or impressed current.

"Cathodic protection tester" means a person who can demonstrate an understanding of the principles and measurements of all common types of cathodic protection systems as applied to buried or submerged metal piping and tank systems. At a minimum, such persons must have education and experience in soil resistivity, stray current, structure-to-soil potential, and component electrical isolation measurements of buried metal piping and tank systems.

"Corrosion expert" means a person who, by reason of thorough knowledge of the physical sciences and the principles of engineering and mathematics acquired by a professional education and related practical experience, is qualified to engage in the practice of corrosion control on buried or submerged metal piping systems and metal tanks. Such a person must be accredited or certified as being qualified by the National Association of Corrosion Engineers (NACE) or be a registered professional engineer who has certification or licensing that includes education and experience in corrosion control of buried or submerged metal piping systems and metal tanks.

280.20 Performance Standards for New UST Systems

(a) (2) The tank is constructed of steel and cathodically protected in the following manner:

(i) The tank is coated with a suitable dielectric material;

- (ii) Field-installed cathodic protection systems are designed by a corrosion expert;
- (iii) Impressed current systems are designed to allow determination of current operating status as required in 280.31 (c); and
- (iv) Cathodic protection systems are operated and maintained in accordance with 280.31 or according to guidelines established by the implementing agency; or (various industry codes and standards are referenced here – see Appendix A).

280.31 Operation and Maintenance of Corrosion Protection

- (a) All corrosion protection systems must be operated and maintained to continuously provide corrosion protection to the metal components of that portion of the tank and piping that routinely contain regulated substances and are in contact with the ground.
- (b) All UST systems equipped with cathodic protection systems must be inspected for proper operation by a qualified cathodic protection tester in accordance with the following requirements:
 - (1) *Frequency.* All cathodic protection systems must be tested within 6 months of installation and at least every 3 years thereafter.
 - (2) *Inspection Criteria.* The criteria that are used to determine that cathodic protection is adequate as required by this section must be in accordance with a code of practice developed by a nationally recognized association.
- (c) UST systems with impressed current cathodic protection systems must also be inspected every 60 days to ensure the equipment is running properly.
- (d) For UST systems using cathodic protection, records of the operation of the cathodic protection must be maintained (in accordance with 280.43) to demonstrate compliance with the performance standards in this section. These records must provide the following:
 - (1) The results of the last three inspections required in paragraph (c) above;
 - (2) The results of testing from the last two inspections required in paragraph (b) above.

280.31 Repairs Allowed

- (e) Within 6 months following the repair of any cathodically protected UST system, the cathodic protection system must be tested in accordance with 280.31 (b) and (c) to ensure that it is operating properly.

SECTION 3 - TYPES OF CATHODIC PROTECTION

3.1 General

The two types of cathodic protection that are typically installed on UST systems are galvanic (sacrificial anode) and impressed current systems. An attempt to explain the principles involved in the theory of cathodic protection is beyond the scope of this document and it is assumed the reader has a basic understanding of the subject. However, stated in the simplest terms, both of these types of cathodic protection attempt to reverse the flow of electric current away from the metal that is intended to be protected from corrosion. Both types of cathodic protection prevent electric current from leaving the protected structure by supplying an electrical charge in the form of DC power sufficient to overcome any current that would otherwise leave the structure. The way in which the required electrical current is provided is what distinguishes the two types of cathodic protection.

3.2 Galvanic Systems

Galvanic systems are also known as sacrificial anode systems because an anode (usually zinc or magnesium) corrodes instead of the protected metal. Because the anode corrodes instead of the metal that it is protecting, the anode is said to sacrifice itself. Sacrificial anodes are connected directly to the structure to be protected by either welding or mechanical connection of lead wires.

Galvanic systems are generally limited to those tank components that are well coated with a dielectric material (sti-P₃[®] tanks or fusion bonded epoxy coated steel piping) because the available current output of these systems is low. Attempts to protect long runs of uncoated piping or uncoated tanks generally is not practical because the useful life of the anodes is too short or the number of anodes needed is too great.

3.3 Impressed Current Systems

Impressed current systems are sometimes called rectifier systems because they utilize a device (a rectifier) to convert an external AC power source to the required DC power source. In this type of system, anodes are installed in the soil around the structure to be protected and the DC power is supplied to the anodes through buried wires. The power to the rectifier cannot be interrupted except when conducting maintenance or testing activities. Normally, a dedicated and protected circuit is provided for the impressed current system so that the power cannot be inadvertently cut off.

In impressed current systems the protected structure is bonded to the DC power system to complete the electrical circuit. It is critical that the anodes are connected to the positive terminal and the protected structure to the negative terminal of the rectifier. Reversal of the lead wires will make the components of the tank system anodic and can cause a rapid failure of the tank system due to corrosion. In addition, it is critical that all wire connections and splices are well insulated. Any breaks in the wiring insulation will allow current to leave the wire at that point and a rapid failure of the wire can occur due to corrosion.

Impressed current systems are generally installed on those tank systems that were installed prior to the effective date of the UST regulations since these tanks usually do not have a good dielectric coating. The level of cathodic protection provided by an impressed current system can be adjusted since the voltage produced by the rectifier can be changed. Because conditions that affect the level of cathodic protection needed are likely to change over time, adjustment of the rectifier is frequently necessary.

SECTION 4 – QUALIFICATIONS TO TEST CATHODIC PROTECTION SYSTEMS

4.1 Qualifications

In order to test cathodic protection systems in the State of Mississippi, an individual must meet certain minimum qualifications. It is the intent of the MDEQ that those individuals who meet the minimum qualifications perform testing in a manner that is consistent with the policies of this guidance document. Should an individual who meets the minimum qualifications as described below not possess the knowledge and expertise needed to properly evaluate a cathodic protection system, that individual should not attempt to undertake such an evaluation.

While it is not necessary to be an “expert” to test cathodic protection systems in most cases, it should be recognized that the proper evaluation of the two types of cathodic protection systems may require differing levels of expertise. Impressed current systems are inherently more involved and require a higher level of understanding than galvanic systems. In addition, certain circumstances and conditions may exist that would preclude an individual from making an effective evaluation of a cathodic protection system without the assistance of someone who is more qualified.

Because the testing of impressed current systems is inherently more complicated, someone who is only minimally qualified as a “tester” should recognize that he may or may not be able to properly evaluate all such systems. Galvanic cathodic protection systems that are operating as designed are normally straightforward and a lesser degree of expertise is needed to properly evaluate such systems. However, troubleshooting and/or repair of such systems may require someone who has a higher level of expertise than a person who is only minimally qualified as a tester.

Scenarios that require an expert to either conduct or evaluate the cathodic protection survey are listed in Section 7.2 of this document. It should be recognized that there might be other circumstances that require an expert although they may not be specifically listed. A listing of those individuals who meet the qualifications of an expert (certified as either as a “corrosion specialist” or a “cathodic protection specialist”) can be found at the web site of NACE International (www.nace.org).

Listed below are the minimum qualifications necessary to test cathodic protection:

- Anyone who meets the definition of “cathodic protection tester” as found in 40 CFR 280.10 is recognized as qualified to test cathodic protection.
- Anyone who holds a certification from NACE International which that organization recognizes at a minimum as qualifying that person as a cathodic protection tester.
- Anyone who is certified by the MDEQ as a UST installer is recognized as being able to test cathodic protection systems provided they are familiar with the concepts involved and abide by the requirements contained within this guidance document. If a UST installer does not understand the basic concepts related to the testing, maintenance and operation of cathodic protection systems, that person should not attempt to evaluate such systems.

Should it be determined that a MDEQ certified UST installer is conducting evaluations of UST cathodic protection systems in a manner that is not consistent with the intent of the MDEQ policy, they may be subject to penalty and/or revocation of their UST installer certification upon a determination of good cause by the Mississippi Commission on Environmental Quality.

SECTION 5 - INSTALLATION/REPAIR OF CATHODIC PROTECTION SYSTEMS

5.1 Galvanic Systems

5.1.1 sti-P₃[®] Tanks

Anyone who is a MDEQ certified UST installer may repair the cathodic protection system of a sti-P₃[®] tank provided any provisions the tank manufacturer may have are also met. The design requirements for the installation of additional sacrificial anodes to a sti-P₃[®] tank may be met without the need for a corrosion expert to design such, provided the provisions of the Steel Tank Institute "Recommended Practice for the Installation of Supplemental Anodes for sti-P₃[®] UST's R-972-01" are followed. An evaluation of the cathodic protection system must be conducted within six months of the installation/repair in accordance with the requirements of this document.

5.1.2 Factory Coated Metallic Piping

Installation of sacrificial anodes to factory coated (fusion bonded epoxy) metallic piping may be accomplished without the design of a corrosion expert provided the provisions of the Steel Tank Institute "Recommended Practice for Corrosion Protection of Underground Piping Networks Associated with Liquid Storage and Dispensing Systems R892-91" are followed. As an alternative, the practices as described in the Petroleum Equipment Institute "RP 100-2000 Recommended Practices for the Installation of Underground Liquid Storage Systems" may also be followed when installing sacrificial anodes on factory coated piping.

5.1.3 Non-factory Coated Metallic Piping

The installation and/or repair of a galvanic cathodic protection system installed on metallic piping that is not factory coated with a dielectric material may be accomplished by anyone who is a MDEQ certified UST installer. However, the design of the galvanic cathodic protection system must be accomplished by a corrosion expert. In addition, an evaluation of the cathodic protection system must be conducted within six months of the installation/repair in accordance with the requirements of this document.

5.1.4 Metallic Piping Repair/Installation

Provided below are some general observations that are commonly applicable to questions that arise when attempting to meet the corrosion protection requirements on metallic piping and other metallic components of a typical UST system.

Protected Components - Any metallic component of the piping system, including all metallic nipples, ells, tees, couplings, unions, ball valves, etc. must be protected from corrosion if they are in contact with the soil and/or water. Corrosion protection may be accomplished by either a) isolating the component in question from contact with the soil and/or water or b) coating/wrapping with a suitable dielectric material and cathodic protection. Any isolation boot or containment sump designed to isolate the metallic component from contact with the soil must also prevent water from contacting the component in question in order to eliminate the need for cathodic protection. If the metallic component in question is cathodically protected, it must also be coated/wrapped with a suitable dielectric material if it was installed after December 22, 1988.

Unprotected Components - Metallic components of the UST system that do not require corrosion protection include: tank vent lines; any type of tank riser pipe; tank hold down straps; remote tank fill lines and submersible turbine pump (STP) heads. Although the pump head "routinely contains

product”, it is not required to meet the corrosion protection requirements and may be in contact with the soil or submerged in water without the need for cathodic protection. However, the pump head should remain visible (not buried) so that any obvious corrosion problems or leaks that may be present can be observed and appropriate action taken to prevent or repair any leaks.

Repair - Some confusion exists over whether or not metallic piping that has failed can be repaired or must be replaced. “Repaired” as related to steel pipe involves the replacement of the section of pipe that has failed. The entire run of steel piping does not have to be replaced but the repair must consist of replacement of the section of pipe that has failed. Only steel pipe that is factory coated with a dielectric material (fusion bonded epoxy) can be used to replace the failed section of pipe regardless of whether the existing pipe is galvanized or coated steel. Under no circumstances is it allowable to install galvanized piping when it is intended to serve as a product transfer line. Because of the complexities that may be involved in the cathodic protection of galvanized steel piping, a corrosion expert must evaluate and/or conduct the cathodic protection survey after the repair.

Electrical Continuity - Dielectric unions are normally not installed if the piping is protected by an impressed current system. It is essential that all metallic piping that is part of the UST system is bonded to the negative circuit of the impressed current system if it is buried. It is normally desirable to electrically isolate any metallic portion of the UST system that is not buried or submerged in water from that portion that is buried/submerged.

Electrical Isolation - If metallic piping is galvanically protected, it is critical that effective electrical isolation is provided. Failure to isolate the protected piping will result in premature failure of the sacrificial anodes. Isolation can be difficult to achieve where cathodically protected piping is present under dispensers that have shear valves present. This is due to the requirement that the shear valve must be properly anchored to the island form. Particular care should be exercised in these instances to assure proper isolation. If possible, the dielectric union should be installed below the shear valve so that anchoring does not cause a continuity problem.

Screw Joints - Particular care should be taken when dealing with metallic piping that is mechanically coupled with threaded screw joints. Any threaded joint in a metallic piping material can serve as a break in the electrical continuity of the piping system. It has been established that threaded couple pipe joints can develop enough electrical resistivity over time to effectively isolate each section of a piping system. For obvious reasons, this is highly undesirable in a cathodic protection system and you should ensure that electrical continuity is present between any sections of piping that are intended to be protected. Jumper wires or welding may be necessary across each pipe couple in order to assure electrical continuity between each section of piping.

Flex Connectors - Any metallic flexible connector (including stainless steel) that is utilized on a piping system must be protected from corrosion. The flex connector may be isolated from contact with soil/water or cathodically protected. If the flex connector is cathodically protected, it must also be coated/wrapped with a dielectric material if it was installed after December 22, 1988.

Containment Sumps - If metallic components of a piping system are installed in a containment sump, the sump must be maintained dry. If a sump contains water and you are unable to keep the water out, the metallic components must be protected from corrosion. The metallic components may be protected by installing appropriate isolation boots (in the case of flex connectors) or sacrificial anodes. If cathodic protection is necessary, the sump may or may not be filled with clean sand to a depth adequate to bury the anode. Burial of the anode may help prevent an oxidation film from forming on the anode (and causing passivation) in the event that standing water is not always present in the sump. In either case, it is critical that the anode be installed within the containment

sump. Do not place the anode outside of the sump. Note that any cathodically protected component installed after December 22, 1988 must also be coated/wrapped with a suitable dielectric material.

“Mixed” Piping - In those instances where fiberglass reinforced plastic or flexible piping is connected to an existing metallic pipe (e.g. to extend a fueling island), a cathodic protection test station or access to the soil where the two dissimilar materials are joined must be provided. This is necessary to effectively test the adequacy of cathodic protection operating on the metallic piping.

5.2 Impressed Current Systems

Anyone who is a MDEQ certified UST installer may install and/or repair an impressed current cathodic protection system. However, the design of an impressed current system must be accomplished by a corrosion expert. If the repair of an impressed current cathodic protection system results in the reconfiguration of any of the components of the system, then the reconfiguration must also be designed by a corrosion expert.

If the repair only involves the replacement of existing components, a corrosion expert does not need to “sign-off” on such work. However, after any repair/alteration of the impressed current system is made, an evaluation of the cathodic protection survey must be conducted within six months of the repair. If the repair/alteration results in any of the conditions found in Section 7.2 of this document being met, the cathodic protection survey must be conducted/evaluated by a corrosion expert.

5.2.1 Rectifier Adjustment

Anyone who is considered qualified as a cathodic protection tester may adjust the rectifier output/voltage of an impressed current cathodic protection system. An evaluation of the cathodic protection system must be conducted whenever an adjustment to the rectifier is made. Before making any adjustments to the rectifier, the power must be turned off. Open both the AC and the DC circuit breakers.

It should be recognized that increasing the rectifier output could cause an increase in the potential for stray current to be generated that may have a detrimental effect on other buried metallic structures at the facility. Excessive rectifier output can also significantly shorten the life of the anode ground bed since the anodes will be consumed more quickly than necessary. In addition, care should also be taken to ensure that components of the rectifier do not become overheated (causing a potential fire hazard) as a result of increasing the output.

When evaluating the operation and output of a rectifier, it is important to make all measurements with a good quality multimeter. Do not rely on the output indicated by the voltmeter and/or ammeter that may be installed on the rectifier. Most rectifier gauges are adjustable and you should make any adjustment that may be indicated by measurement with the portable multimeter.

The gauges that are commonly built into rectifiers are usually not accurate and may even be frozen in a fixed position. If the indicator needle is frozen on the rectifier voltmeter/ammeter and cannot be freed, you should replace the gauge. If replacement is not accomplished, you should note that the gauge is not functioning so that an observer will be able to discern that the gauge is inoperable.

For the reasons given above and other considerations, a person qualified as a corrosion expert should be consulted whenever the output is adjusted or repairs are made to the rectifier.

SECTION 6 - CATHODIC PROTECTION TESTING

6.1 Equipment

Although the equipment required to test cathodic protection systems is relatively simple, it is very important that the equipment be maintained in good working order and is free of corrosion and contamination. The basic equipment includes a voltmeter/ammeter (multimeter), reference electrode, wires, clips and test probes.

It may also be necessary to have a current interrupter for impressed current systems when the power cannot be easily cut on and off at the rectifier. A clamp-on type ammeter can be useful when troubleshooting impressed current systems. Wire locators can help determine the location of buried anode lead wires and header cables. Hand tools to clean corrosion or dielectric coatings from the surface of the structure you are testing at the point of contact with lead wires/probes may also be necessary.

6.1.1 Voltmeter/Ammeter

A good quality voltmeter/ammeter (multimeter) that has an adequate degree of accuracy is essential for testing cathodic protection due to the low voltage/current involved. Most "low end" voltmeters/ammeters are not capable of achieving results accurate enough to ensure reliable results and should therefore not be used.

All testing of cathodic protection systems must be accomplished with a high internal resistance (impedance of 10 meg-ohms or greater) voltmeter that is properly maintained and periodically calibrated in accordance with the manufacturer's recommendations. The voltmeter should be calibrated at least on an annual basis. It is important that the voltmeter has a high internal resistance in order to avoid introducing a large error when measuring structure-to-soil potentials.

The voltmeter must have a high degree of sensitivity and must be placed in as low a scale as possible (normally the 2 volt DC scale works well) in order to accurately measure the small voltages associated with cathodic protection systems. All voltage measurements obtained should be recorded as millivolts (mV). For example, a reading of -1.23 volts should be recorded as -1230 mV; a reading of -.85 volts should be recorded as -850 mV.

Voltmeters that have a variable input resistance can be utilized to ensure that contact resistance between the reference electrode and the electrolyte has been evaluated as a source of error (voltage drop) in the observed structure-to-soil potential. This is accomplished by changing the input resistance and noting whether or not the voltage observed changes significantly. If no voltage change is observed when the input resistance is changed, it can be assumed that contact resistance is not causing an error in the structure-to-soil potential measurement.

An ammeter that has a very low internal resistance is necessary when testing impressed current systems in order to accurately determine the current output of the rectifier and/or individual circuits in the system. Generally, amperage should only be measured where calibrated measurement shunts are present. Alternatively, a "clamp-on" type ammeter may be utilized in those cases where shunts are not present.

The batteries in the portable multimeter must also be in good condition. Batteries that are in poor condition can cause unintended errors. If there is any question about the condition of the batteries in the multimeter, they must be replaced.

6.1.2 Reference Electrode

A standard copper/copper sulfate reference electrode (also known as a half cell or reference cell) must be utilized in order to obtain structure-to-soil potentials. The reference electrode must be maintained in good working condition and must be placed in the soil in a vertical position when conducting a test.

On those sti-P₃[®] tanks that have a PP4[®] test station, a reference electrode is permanently buried in the tank pit. Since it is generally not possible to determine where the permanent reference electrode was installed on these types of systems, it is also necessary to conduct structure-to-soil potential measurements in the conventional manner (i.e. with a portable reference electrode in the soil directly over the tank and at a remote placement). A tank may not be passed on the basis of a structure-to-soil potential obtained with a PP4[®] test station. Both the local and the remote potential obtained in the conventional manner must indicate that adequate cathodic protection has been provided regardless of what the PP4[®] test station indicates.

Maintenance of the reference electrode is important for accurate results and includes:

- a. The copper-sulfate solution inside the reference electrode should be clear. If the solution appears cloudy, this may indicate that the solution has become contaminated and the reference electrode should be compared with the known standard as described in paragraph e below. Should it be necessary to replace the solution, only distilled water and new copper-sulfate crystals should be used. Excess copper-sulfate crystals must be present in order to assure a saturated solution. Under average conditions, it is usually a good idea to empty and replace the solution every 2 or 3 months.
- b. The porous ceramic tip must be maintained moist at all times. If the tip is allowed to dry out, it may lose its porosity and a good low resistivity contact with the soil will not be possible. Periodic replacement of the tip may be necessary.
- c. The copper rod inside the reference electrode should periodically be cleaned with non-metallic sandpaper. Do not use black metal oxide sandpaper, steel wool or any other metallic abrasive as this can cause the copper rod to become contaminated. If the copper rod becomes contaminated, it is best to replace the reference electrode.
- d. The copper-sulfate solution must be free of contamination or errors will be introduced in the readings you observe. If the reference electrode is submerged in water or placed in moist soils that are contaminated, it is likely that the solution will become contaminated.
- e. The reference electrode that is used in the field must be periodically calibrated. How often the reference electrode needs to be calibrated depends upon several different factors. Among the more important factors that should be considered are the frequency of use and the exposure of the reference electrode to contaminants. As a general rule, calibration should be checked once every week if the reference electrode is used daily. If the reference electrode is only periodically used, calibration should be checked prior to each use.

Calibration of the reference electrode is accomplished by comparing it with another reference electrode that has never been used. The unused reference electrode that is to act as the calibration standard should be properly set up (ready for use) and must not have ever been used in the field so that no chance of contamination exists. Consideration should be given to obtaining a reference electrode that is certified by the manufacturer to be properly calibrated for periodic calibration of the field electrode.

To calibrate the field electrode:

1. Place the voltmeter on the 2 volt DC scale (or lower) and connect the leads to the reference electrodes as shown in the illustration below.
2. Place both the field electrode and the standard electrode in a shallow nonmetallic container that has one to two inches of tap water in the bottom of it. Do not use distilled water. The reference electrodes must be placed vertically in the container with the ceramic tip of each submerged in the water.
3. Observe the potential measurement displayed on the voltmeter. If more than 10 mV potential exists between the two reference electrodes, the field reference electrode should be properly cleaned and refilled with new solution until the potential difference is 10 mV or less. If you are unable to achieve a 10 mV or less potential difference after cleaning/reconditioning, the field electrode must be discarded and a new one obtained.
4. In order to lessen the chance of cross contaminating the calibration electrode, you should leave the calibration electrode in the water for the shortest time necessary to complete the test.

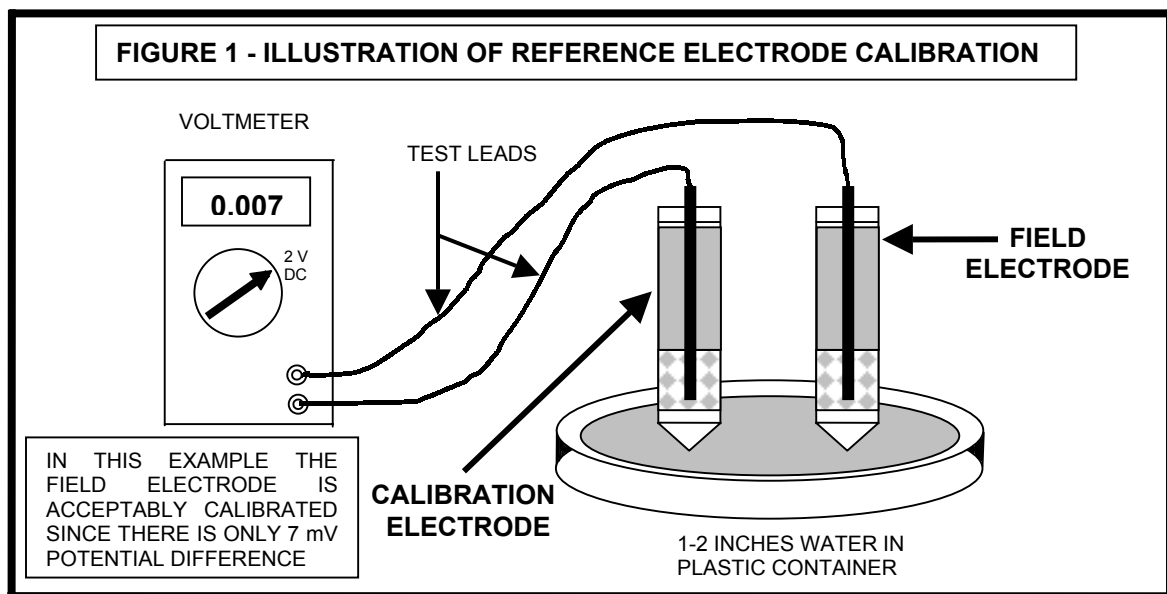

6.1.3 Lead Wires/Test Probes/Miscellaneous

You should ensure that the insulation material of any lead wires is in good condition. Any clips or probes used to make contact with the structure to be tested must be clean and free of corrosion. A spool of suitable wire of sufficient length is necessary to conduct continuity and/or “remote earth” testing. It is usually necessary to have a probe that can be attached to the end of a tank gauging stick in order to contact the tank bottom since it is not uncommon for the test lead on sti-P₃[®] tanks to either be missing or discontinuous with the tank shell. A pair of locking pliers can sometimes be useful when attempting to get a solid connection.

6.2 Test Criteria

There are three test criteria that can be utilized to indicate if adequate cathodic protection is being provided to the structure being evaluated:

850 On - A structure-to-soil potential of -850 mV or more negative with the protective current applied. This is commonly referred to as “850 on” or the “on potential”. This criterion is normally the only one available for galvanic systems since the protective current usually cannot be interrupted.

Voltage drops (see Section 6.3) other than those across the structure to electrolyte boundary must be taken into consideration whenever this criterion is applied. Voltage drops may have a significant impact on the potentials observed when testing impressed current systems with the protective current applied. Therefore, the 850 on criterion is not applicable to impressed current systems.

850 Off - A structure-to-soil potential of -850 mV or more negative with the protective current temporarily interrupted. This is referred to variously as “850 off”, “polarized potential” or “instant off potential”. This criterion is applicable to impressed current and galvanic systems where the protective current can be interrupted. Caution must be exercised when testing impressed current systems to ensure that no active sacrificial anodes are also installed near the protected structure. If there are active anodes influencing the observed potential, the 850 off criterion is not applicable.

The instant off potential is the 2nd value that is observed on a digital voltmeter the instant the power is interrupted. The first number that appears immediately after power interruption must be disregarded. After the second number appears, a rapid decay (depolarization) of the structure will normally occur. In order to obtain instant off potentials, a current interrupter or a 2nd person is necessary. If a current interrupter is not available, have the second person throw the power switch at the rectifier off for 3 seconds and then back on for 15 seconds. Repeat this procedure until you are sure an accurate instant off reading has been obtained.

This criterion is considered by most to be the best indicator that adequate cathodic protection has been provided. Therefore, consideration should be given to adjusting the rectifier output upward until the 850 off criterion has been met if this is feasible.

100 mV Polarization - A polarization voltage shift of at least 100 mV. Commonly referred to as “100 mV polarization” or “100 mV shift”. This criterion is applicable to galvanic and impressed current systems where the protective current can be temporarily interrupted. Either the formation or the decay of at least 100 mV polarization may be used to evaluate adequate cathodic protection.

The “true” polarized potential may take a considerable length of time to effectively form on a structure that has had cathodic protection newly applied. If the protective current is interrupted on a metallic structure that has been under cathodic protection, the polarization will begin to decay nearly instantaneously. For this reason, it is important that the protective current not be interrupted for any significant length of time. Generally, not more than 24 hours should be allowed for the 100 mV depolarization to occur. On a well-coated structure complete depolarization may take as long as 60-90 days. Complete depolarization of uncoated structures will usually occur within 48 hours although it could take as long as 30 days.

The base reading from which to begin the measurement of the voltage shift is the instant off potential. For example, a structure exhibits an on voltage of -835 mV. The instant off voltage is -720 mV. In order to meet the 100 mV polarization criteria, the structure-to-soil potential must decay to at least -620 mV (final voltage).

The use of native potentials to demonstrate the formation of 100 mV polarization is generally only applicable when a system is initially energized or is re-energized after a complete depolarization has occurred. This is because it is necessary to leave the reference electrode undisturbed (or returned to the exact position) between the time the native and the final voltage are obtained.

It is only necessary to conduct a 100 mV polarization test on that component of the UST system where the lowest (most positive) instant off structure-to-soil potential exists in order to demonstrate that the UST system meets this criterion. If the criterion is met at the test point where the potential is most positive, it can be assumed that it will be met at all other test locations.

6.3 Voltage (IR) Drops

The effect voltage drops have must be considered whenever structure-to-soil potentials are obtained during the survey of a cathodic protection system. The concept of voltage drops is a difficult and controversial subject and a full discussion is beyond the scope of this document. However, stated in the simplest terms, a voltage drop may be thought of as any component of the total voltage measurement (potential) that causes an error.

The term IR drop is sometimes used and it is equivalent to voltage drop. IR drop is derived from Ohm's Law which states that $V = I R$. In this equation, V stands for voltage, I represents current (amperage) and R stands for resistance. Because the observed voltage is equal to the amperage (I) multiplied by the resistance (R) a voltage drop is commonly referred to as an IR drop. There are various sources of voltage drops and two of the more common are discussed below.

Current Flow - Whenever a current flows through a resistance, a voltage drop is necessarily created and will be included whenever a measurement of the electrical circuit is conducted. In order to effectively eliminate this voltage drop when testing impressed current systems, it is necessary to interrupt the protective current. The magnitude of the voltage drop obtained on impressed current systems is evaluated by conducting both on and instant off potential measurements.

To illustrate how this type of voltage drop contributes to the potential observed when measuring impressed current systems consider the following example. A potential of -950 mV is observed when the rectifier is on. A potential of -700mV is observed when the power is interrupted. Taking the absolute values (negative is dropped), the voltage drop component of the on potential is 250 mV ($950 - 700 = 250$). Figure 2 is a graphical representation of this voltage drop and also shows how the instant off potential will degrade over time until the native potential is reached.

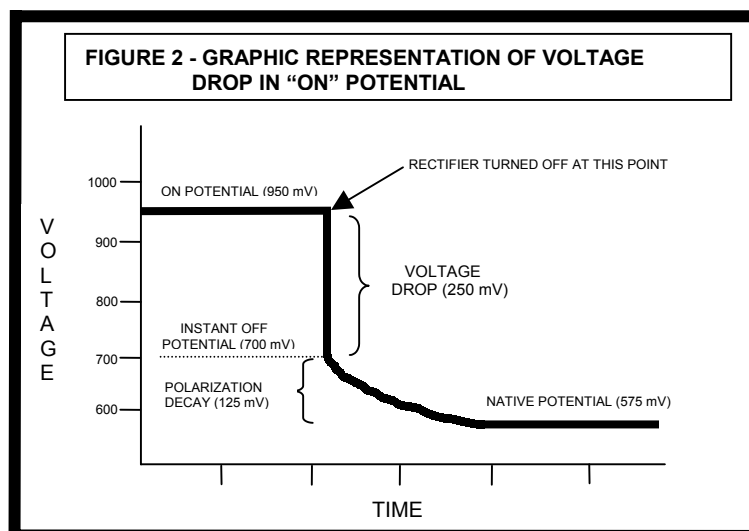

Raised Earth - All active anodes will have a voltage gradient present in the soil around them producing a “raised earth effect”. An abnormally high (more negative) potential will be observed if the reference electrode is within the voltage gradient of an active anode. The magnitude or area of influence of the voltage gradient is dependent predominantly on the voltage output of the anode and the resistance of the soil. Unfortunately, there is no “rule of thumb” guidance that can be given to determine how far away you must be from an anode in order to be outside the voltage gradient. If you suspect the potential you obtain may be affected by raised earth, you should take a remote reading and compare the two.

Because of the raised earth effect, it is necessary to place the reference electrode as far away from any active anode (and still be directly over the structure) when obtaining local potentials on galvanic systems. Since the protective current can not typically be interrupted in galvanic systems, any effect this type of voltage drop may have is evaluated by placing the reference electrode remote. Placement of the reference electrode remote ensures that the reference electrode is not within the voltage gradient of an active anode. Since it is desirable to eliminate any effect voltage drops may have, it is necessary to obtain both local and remote structure-to-soil potentials on galvanic systems. Any effect raised earth may have when testing impressed current systems is eliminated by temporarily interrupting the power.

6.4 Stray Current

An unintended current that is affecting the structure you are trying to protect is referred to as a stray current. Stray currents can cause rapid corrosion failure of a buried metallic structure and are caused by an electric current flowing through the earth in an unintended path. If the metallic object you are trying to cathodically protect is buried near the path of the stray current, the current may “jump-on” the protected structure because it offers a lower resistance path for the current to flow. The affected structure will be cathodic where the stray current enters but will be highly anodic where the stray current returns to the earth. At the point where the current discharges, rapid corrosion of the structure intended to be protected will occur.

Although stray currents are relatively rare on UST systems, common sources include: a) Railroad crossing signals (powered by batteries); b) Traffic signals that have induction type sensors buried in the pavement; c) Portable or fixed emergency power generators; d) Electrical railway systems such as streetcars or subways in urban areas; e) DC welding operations and other types of industrial machinery or processes that utilize DC power.

If unsteady readings are observed on the protected structure and you have determined that it is not because of a bad electrical connection, you should suspect that stray current is affecting the protected structure. In some cases, a pattern can be seen in the potential whereby it alternates between two relatively stable readings. These patterns can sometimes help to identify the source of the stray current. If you suspect that stray current may be affecting the UST system, a thorough investigation must be conducted as soon as possible by a qualified corrosion expert since stray current can cause a rapid failure of the affected structure.

Cathodic Interference - When the impressed current cathodic protection system operating on the structure you are trying to protect causes an unintended current on some other nearby structure, this type of stray current is referred to as “cathodic interference”. Cathodic interference can cause a rapid failure of the water lines and other buried metallic structures at the facility where the cathodic protection system is operating. If you observe what you believe to be an abnormally high (more negative) potential on a buried metallic structure, you should suspect that the impressed current system operating on the UST system is causing cathodic interference.

Instances where cathodic interference may be present include: a) copper water lines that are not bonded to the impressed current system and have a polarized potential of greater than -200 mV; b) metallic flex connectors associated with fiberglass reinforced plastic piping that have abnormally high (more negative) potentials and are not bonded to the impressed current system; c) sti-P3[®] tanks are buried at a facility where there is an impressed current system operating and are not bonded to the negative circuit. When the sti-P3[®] tanks have zinc anodes and a potential more negative than -1100 mV (more negative than -1600 mV in the case of magnesium anodes) is observed, it is likely that cathodic interference is occurring. Because of the potential for stray current to impact sti-P3[®] tanks, it is normally necessary to bond them into the impressed current system.

A corrosion expert must be consulted whenever cathodic interference is suspected in order to properly investigate and make any repairs/modifications that may be necessary.

6.5 Dissimilar Metals/Bimetallic Couples

The effect bimetallic couples may have must also be considered whenever structure-to-soil potentials are obtained during the survey of a cathodic protection system. The concept of dissimilar metals/bimetallic couples and the impact they can have on the proper evaluation of cathodic protection systems is a difficult and controversial subject and a full discussion is beyond the scope of this document. However, you should be aware that bimetallic couples may substantially influence the structure-to-soil potentials of a tank system to the extent that the 100 mV polarization criterion is not applicable. Because the validity of the 100 mV criterion may be suspect, consideration should be given to only utilizing the -850 mV instant off criterion when evaluating impressed current systems. A brief discussion follows.

Caution must be exercised when evaluating steel UST systems that have metals of lower electrochemical potential electrically connected to them. Typically, bimetallic couples are only of concern on impressed current systems since those steel components protected by galvanic systems are electrically isolated from other metallic structures. Copper is the metal of lower potential that is commonly of concern. Sources of copper at UST facilities include the water service lines and the grounding system of the electrical power grid. Since the AC power supply to the submersible turbine pump should be continuous with the electrical service grounding system, which may in turn be continuous with the water lines, a significant amount of copper may be coupled to the steel UST system.

The effect this type of bimetallic couple has on the impressed current system can sometimes be clearly seen on those UST systems that store fuel for emergency power generators. Commonly these generator tank systems are installed with copper supply and return lines. When these tanks were retrofitted with an impressed current system, the copper lines were bonded into the cathodic protection system. In these instances, it is not uncommon to observe native structure-to-soil potentials on the UST system of -450 mV or more positive.

If the native structure-to-soil potential of the UST system is substantially lower than what you would normally expect, it is likely that a significant amount of copper is electrically bonded to the UST system. Typically, the expected native potential of a steel UST system should not be more positive than -500 mV.

To illustrate the effect of the copper-steel couple, consider the following example: A steel UST system that is coupled to copper has a native structure-to-soil potential of -300 mV with the bimetallic couple intact. If the copper couple is broken the UST system native potential is -600 mV. With the copper couple intact, the polarized (off) potential of the UST system -450 mV. Although the voltage shift satisfies the 100 mV polarization criterion (from -300 mV to -450 mV), it is likely that the

steel UST system is not adequately protected. This is because the UST system is not polarized at least 100 mV beyond the native potential of the steel. Since the true native potential of the steel UST system in this example is -600 mV, you would need to reach a polarized (instant off) potential of -700 mV or more negative.

Because the unaffected native potential of steel UST systems is generally not known, the application of the 100 mV polarization criterion would be inappropriate when there is a significant amount of copper (or other more noble metal) electrically continuous. For this reason, it is always desirable to demonstrate that the UST system satisfies the 850 off criterion when evaluating a cathodic protection system.

6.6 Other Test Considerations

Various other factors can affect the accuracy of structure-to-soil potentials. Listed below are some of the more common factors that you should keep in mind:

Contact Resistance – In order to obtain an accurate structure-to-soil potential, a good (low resistivity) contact between the reference electrode and the soil must be made. Sometimes, the soil at the surface is too dry and water needs to be added in order to lower the resistance between the reference electrode and the soil. In addition, if the porous ceramic tip of the reference electrode becomes clogged or contaminated it should be replaced since this in itself can cause a high contact resistance.

Contaminated Soil – You should ensure that the soil the reference electrode is placed in is free of contamination. Hydrocarbon contamination can cause a high resistance between the reference electrode and the soil.

Current Requirement Testing – When a current requirement test is conducted on galvanically protected tanks (refer to STI R972-01 for a description of this test), the affected structure can exhibit an elevated (more negative) structure-to-soil potential during the test and for a period of time after the test is completed. This is due to a temporary polarization of the tested structure which will dissipate over a period of time ranging from a few minutes to perhaps a few days depending on several different factors. Therefore, time sufficient for the temporary polarization of the affected structure to “drain-off” after a current requirement test is conducted must be allowed before an accurate structure-to-soil potential can be obtained. In addition, any potential measured with the battery connected should be disregarded as this measurement contains a large voltage drop. Only instant off voltages are meaningful when the battery is connected.

Drought Conditions – On occasion, it has been observed that structure-to-soil potentials can be improved by running water into the backfill material of the tank bed when extended periods of no rain have occurred. This is commonly done by placing a water hose in one of the tank bed monitoring wells (or other access points) and allowing the water to run for a period of a few hours. This practice serves to lower the resistance of the backfill material. However, you should keep in mind that the resistivity of the soil is not appreciably lowered if the moisture content is 20% or higher.

Electrical Shorts – When a substandard reading is observed on a galvanically protected system, it is common to find that some other metallic object is electrically connected to the protected structure. For instance, on sti-P₃[®] tanks, the nylon bushings installed in the tank bungs were sometimes removed when the various risers and other tank system components were installed or an electrical conduit was buried in contact with the tank shell.

Electromagnetic Interference – Overhead high voltage power lines, railroad crossing signals, airport radar systems and radio frequency transmitters (CB radios, cellular phones, etc.) can all cause an interference that will result in an inaccurate voltage reading.

Galvanized Metals - Buried metals that have a high electrochemical potential can also influence the voltage observed if the reference electrode is placed in close proximity to such metals. For instance, the steel of some of the man ways that are installed to provide access to the tank appurtenances may be galvanized. If the reference electrode is placed in the soil of such a manway, an artificially high (more negative) potential may be observed. This is actually a raised earth effect although the galvanized metal is not acting to cathodically protect the buried structure of concern.

Parallel Circuits – Care should be taken to ensure that the person conducting the structure-to-soil testing does not allow their person to come into contact with the electrical components of the testing equipment. If the person touches the electrical connections, an error may be introduced due to the creation of a parallel circuit.

Pea Gravel – Because pea gravel or crushed stone typically has a very high electrical resistivity, it is necessary to ensure that it is saturated with water when attempting to measure structure-to-soil potentials with the reference electrode placed in the pea gravel. Evaluate any effect high contact resistance may have by changing the input resistance of the voltmeter as described in Section 6.1.1. As an alternative way to evaluate the effect contact resistance may have, place the reference electrode remotely. If the remote reading is substantially more negative than the local, high resistance is indicated. Placement of a saturated sponge on the surface of the pea gravel may help overcome high contact resistance.

Photovoltaic Effect – It is known that sunlight striking the viewing window of a reference electrode can have an effect (as much as 50 mV) on the voltages observed when conducting testing. You should ensure that the viewing window of the reference electrode is kept out of direct sunlight. As an alternative, the viewing window can be covered with black electrical tape in order to prevent any sunlight from reaching the copper-copper sulfate solution.

Poor Connection – If the observed structure-to-soil potentials are unsteady and the voltmeter will not stabilize, you should suspect a bad connection somewhere. Ensure that all electrical connections are clean and tight and good contact is made between the test lead and the structure.

Shielding – Sometimes, a buried metallic structure that is between the reference electrode and the structure you are attempting to test will cause the reference electrode to be unable to “see” the structure you are testing. Shielding is commonly cited when low potentials are observed with the reference electrode placed locally over sti-P₃[®] tanks due to the various tank risers, pump heads, piping, electrical conduits and metallic manways that are typically located over the tank.

Temperature – The temperature of the reference electrode affects the voltages that are observed when conducting cathodic protection testing. You may need to make a correction to the observed potential in some extreme and/or marginal cases. The “standard” temperature is considered to be 77° F. For every degree less than 77 add 0.5 mV from the observed voltage. For every degree above 77 subtract 0.5 mV from the observed voltage. To illustrate this, consider the following (in order to simplify the calculation, the negative sign is dropped from the structure-to-soil potential): A voltage of 845 mV is observed when the temperature is 57° F. In this case the corrected voltage would then be 855 mV ($20^{\circ} \times 0.5 \text{ mV} = 10 \text{ mV}$. Therefore: $845 \text{ mV} + 10 \text{ mV} = 855 \text{ mV}$).

6.7 Continuity Testing

When conducting an evaluation of a cathodic protection system, it is normally necessary to establish that the cathodically protected components of a UST system are either electrically isolated or electrically continuous depending on the type of cathodic protection system. Ohmmeters (continuity testers) such as those utilized to test automotive wiring circuits are not acceptable for use on buried metallic structures and should never be used for testing continuity of UST system components. The “fixed cell-moving ground” method and the “point-to-point” method are the two commonly utilized ways to test continuity and are discussed in more detail below.

Fixed Cell - Moving Ground Method - The most commonly accepted method of conducting a continuity survey is referred to as fixed cell – moving ground. In this method, the reference electrode is placed at a location remote from any of the cathodically protected structures. Potentials of all the metallic structures present at the site are then measured without moving the reference electrode (refer to Appendix E for a more complete description). Because the conditions found at the reference electrode/electrolyte interface can change over a short period of time (causing the observed potential to change), it is important to conduct this type of testing as quickly as possible.

When determining whether electrical continuity or isolation is provided, the following guidelines are generally accepted for fixed cell – moving ground surveys:

- If two or more structures exhibit potentials that vary by 2 mV or less, the structures are considered to be electrically continuous.
- If two or more structures exhibit potentials that vary by 10 mV or greater, the structures are considered to be electrically isolated.
- If two or more structures exhibit potentials that vary by more than 2 mV but less than 10 mV, the result is inconclusive and further testing (point-to-point) is necessary.

Point-to-Point Method - An easier and usually more accurate way to test continuity is the “point-to-point” method. With this method, a reference electrode is not utilized. The two structures that are to be tested are simply touched with each lead of the voltmeter and the voltage difference (if any) is observed. For example, if you are trying to establish that electrical isolation exists between a tank and the fill riser associated with that tank, you would simply touch the fill riser with one of the voltmeter leads and the tank shell with the other voltmeter lead and observe the voltage difference.

When conducting point-to-point testing, any current that is flowing through the UST components can cause an inaccurate test result. Impressed current systems must be turned off.

When determining whether electrical continuity or isolation is provided, the following guidelines are generally accepted for point-to-point surveys:

- If the voltage difference observed between the two structures is 1 mV or less, the two structures are considered to be electrically continuous with each other.
- If the voltage difference observed between the two structures is 10 mV or greater, the two structures are considered to be electrically isolated from each other.
- If the voltage difference observed between the two structures is greater than 1 mV but less than 10 mV, the result is inconclusive and further testing beyond the scope of this document is necessary.

6.7.1 Continuity Testing of Galvanic Systems

In order for sacrificial anodes to function efficiently, the protected component must be electrically isolated from any other metallic structures that may be connected to or in contact with the protected structure. This is generally accomplished through the use of dielectric bushings and unions and by making sure that no additional metallic structures come into contact with the protected structure.

On those systems where adequate cathodic protection has not been achieved, it is common to find that some unintended metallic structure is electrically continuous with the protected structure. Frequently, an electrical conduit is in contact with a sti-P₃[®] tank or the tank bung nylon bushings are missing or damaged. If metallic tank hold down straps were improperly installed, they will wear through the epoxy coating on the tank over time and cause premature anode failure. With metallic piping, the shear valve anchoring bracket usually provides an electrical bond with the dispenser cabinet and all of the other metal connected to it. When this is the case, the anodes are trying to protect much more metal than intended and the life of the anodes is shortened.

6.7.2 Continuity Testing of Impressed Current Systems

All protected components of the UST system must be electrically continuous in an impressed current cathodic protection system. Various bonds may be required in order to ensure that continuity has been provided. Failure to establish continuity in an impressed current system can result in accelerated corrosion of the electrically isolated components.

Carefully check all bonds when evaluating an impressed current system as these are of critical importance. Commonly, tanks are bonded into the negative circuit by attachment to the tank vent lines above ground. Because of this, it is easy for the integrity of the bonds to be compromised. It is equally important to ensure that the positive lead wire(s) have continuity. Any break in the insulation or dielectric coating of the positive circuit will allow current to discharge from the break and cause rapid corrosion failure of the wire. This is why it is absolutely critical that all buried positive circuit splices are properly coated and insulated.

6.8 Reference Electrode Placement

6.8.1 General

Where you place the reference electrode when taking structure-to-soil potential measurements is of critical importance. It is also essential that the exact location of the reference electrode placement is documented so that anyone could come back at a later date and reasonably duplicate the test. Reference electrode placement must be indicated by both written description and visually shown on a drawing of the tank system. The forms in Appendix K and L of this guidance document provide for both written and visual description of reference electrode placement.

6.8.2 Local Placement

Placement of the reference electrode is considered local when it is in the soil directly over the structure that is being tested. As discussed in Section 6.3, consideration of any effect active anodes have (raised earth) must be considered when selecting the appropriate location for local placement.

In addition, shielding of the reference electrode by other buried metallic components may also need to be considered. For instance, it is necessary to ensure that the tip of the reference electrode is below the metallic skirting found on most man ways. If the tip of the reference electrode is not below the metal skirt, it may be shielded from “seeing” the cathodic protection current.

Ideally, the tip of the reference electrode should be as close to the structure-to-soil interface as is practical in order to minimize the voltage drop present in the soil due to resistivity. In practice, about 6 inches of soil between the tip of the reference electrode and the structure being tested works well.

6.8.3 Remote Placement

The remote potential represents the average potential of the entire surface of the protected structure. The purpose of remote placement is to eliminate any effect that raised earth may be contributing to the measurement of the structure-to-soil potential and to overcome any effects shielding may have.

Placement of the reference electrode is considered remote when it is placed in the soil a certain distance away from the structure that is being tested. There are several different factors that determine the distance necessary in order to reach remote earth and a full discussion is beyond the scope of this document. However, a remote condition can normally be achieved when the reference electrode is placed between 25 and 100 feet away from any protected structure.

Depending on the conditions specific to the particular location where the cathodically protected structure is, the minimum distance to remote earth may be considerably more than 25 feet. Therefore, it is important that you establish that the reference electrode is truly remote when obtaining a structure-to-soil potential. In order to ensure that remote earth has been achieved, place the reference electrode at least 25 feet away from the protected structure and observe the potential. Move the reference electrode out away from the protected structure another 10 feet or so and observe the potential. If there is no significant difference in the two potentials, it can be assumed that remote earth has been achieved. If there is a significant difference, continue moving the reference electrode out away from the protected structure until no significant difference is observed.

When selecting a location to place the reference electrode to establish remote earth, it is essential that there are no other cathodically protected structures (e.g. natural gas lines) in proximity to the reference electrode. Foreign cathodically protected structures can cause an abnormally high (more negative) potential that is not indicative of the remote potential of the structure you are measuring. It is also important that there are no other buried metallic structures in the vicinity of the reference electrode. Any metallic structure that is buried near the reference electrode could possibly affect the structure-to-soil potential that is observed on the protected structure.

In addition to the above considerations, you should attempt to select the remote placement such that the reference electrode can “see” the structure you are testing. This means that there should not be any buried metallic structure between the remote reference electrode placement and the protected structure. If you suspect that shielding may be affecting the observed potential, place the reference electrode away from the protected structure in a different direction.

6.8.4 Galvanic Placement

All galvanic cathodic protection systems must be tested with the reference electrode placed both local and remote. In order to pass the structure-to-soil survey, both the local and the remote potentials must indicate that adequate cathodic protection has been provided. If neither the local or the remote potential satisfies one of the cathodic protection criteria, the structure fails the test. If one of the potentials indicates adequate cathodic protection but the other does not, the result of the test is inconclusive. If the test result is inconclusive, repairs must be made or a corrosion expert must evaluate the data and/or conduct further testing to declare either pass or fail.

6.8.5 Impressed Current Placement

Impressed current cathodic protection systems are only required to be tested with the reference electrode placed locally. In order to pass the survey, the potential obtained with the reference electrode placed locally must satisfy either the 850 off or the 100 mV polarization criteria. While only one test point is required, the tester should obtain structure to soil potentials from as many soil access points along the structure as is practical. If any of the potentials indicate that adequate cathodic protection has not been provided, the structure should be failed.

Although not required by this guidance, it may be useful to place the reference electrode remotely when testing an impressed current system. The remote potential may provide additional information by which to evaluate the cathodic protection system. However, the structure may not be passed based on the remote potential itself. In all circumstances, the potential obtained with the reference electrode placed locally must indicate that adequate cathodic protection has been provided.

Additionally, special circumstances may require that a remote potential be obtained when testing impressed current systems. For instance, if there are active sacrificial anodes buried in close proximity to the structure being tested, the local potential may be influenced by raised earth. The voltage drop caused by the sacrificial anodes would preclude the accurate measurement of the local structure-to-soil potential. If it is known that sacrificial anodes are impacting the potentials obtained locally, remote potentials must be obtained.

The remote potential obtained under these special circumstances must meet either the 850 off or the 100 mV polarization criteria in order for the tested structure to pass the survey. An explanation must be given in the "comments" of Section XVI of the MDEQ impressed current cathodic protection evaluation form as to why the remote potential must be considered. The remote potentials should be indicated on the form by designating remote in the location code column of Section XVI.

6.9 Soil Access

All structure-to-soil potentials that are intended to satisfy one of the three acceptable criteria found in Section 6.2 must be obtained with the reference electrode placed in the soil. Therefore, the person conducting the evaluation must either confirm that soil access is available or make prior arrangements with the owner of the UST system to secure access.

Under no circumstances is it allowable to place the reference electrode on concrete, asphalt, or any other paving material to achieve satisfactory structure-to-soil potentials. Likewise, the practice of placing the reference electrode on a crack or expansion joint of a concrete or asphalt paving is not recognized as an acceptable method of obtaining satisfactory structure-to-soil potentials.

Placement of the reference electrode in an observation (monitoring) well to obtain a passing reading is also not allowed. While it may be useful to obtain data by placing the reference electrode on a crack in the pavement or in an observation well, the structure-to-soil potentials obtained by such placement are not in themselves acceptable to demonstrate adequate cathodic protection.

Access may be provided by drilling holes through the pavement or the installation of proper cathodic protection test stations. A practical way to provide soil access is to drill a ½ inch diameter hole in the pavement so that a "pencil" type reference electrode (3/8 inch diameter) can be inserted through the pavement and into the soil. Upon completion of the survey, the hole should be filled with a fuel resistant caulking material so that easy access can be provided at a later date. As an alternative, a two inch hole could be drilled to allow use of a standard reference electrode. A short length of PVC pipe could be epoxied in the hole and plugged with a threaded cap.

Various cathodic protection test stations/man ways are available for installation. Whenever, a new tank system is installed or the pavement is reworked around an existing system, provisions for access to the soil must be made so that adequate cathodic protection testing may be accomplished.

6.10 Cathodic Protection Test Locations

Because there are many different possible tank and cathodic protection system configurations that may occur, it is not feasible to attempt to illustrate every situation that may exist and the examples given in the following sections are offered as representative of some typical scenarios to illustrate the general principles. It may sometimes be necessary for you to utilize judgement to apply the intent of this guidance document when circumstances arise that are not specifically addressed in this guidance document.

All galvanic cathodic protection systems must be tested with the reference electrode placed both locally and remotely. Impressed current systems are only required to be tested with the reference electrode placed locally.

6.10.1 Galvanically Protected (sti-P₃[®]) Tanks

The measurement of both local and remote structure-to-soil potentials is necessary when evaluating sti-P₃[®] tanks. The appropriate location to place the reference electrode locally would be in the soil at the middle of the tank (see Figure 3). However, if access to the soil is not available at the middle of the tank, the reference electrode may be placed at any point along the centerline of the tank but not directly over the anodes at each end of the tank.

Caution should be exercised to ensure that there are no sacrificial anodes installed in the soil around the submersible pump manway to protect any steel piping that may be associated with the tank. If anodes are installed at the pump manway, the reference electrode must be placed in the soil near the opposite end of the tank.

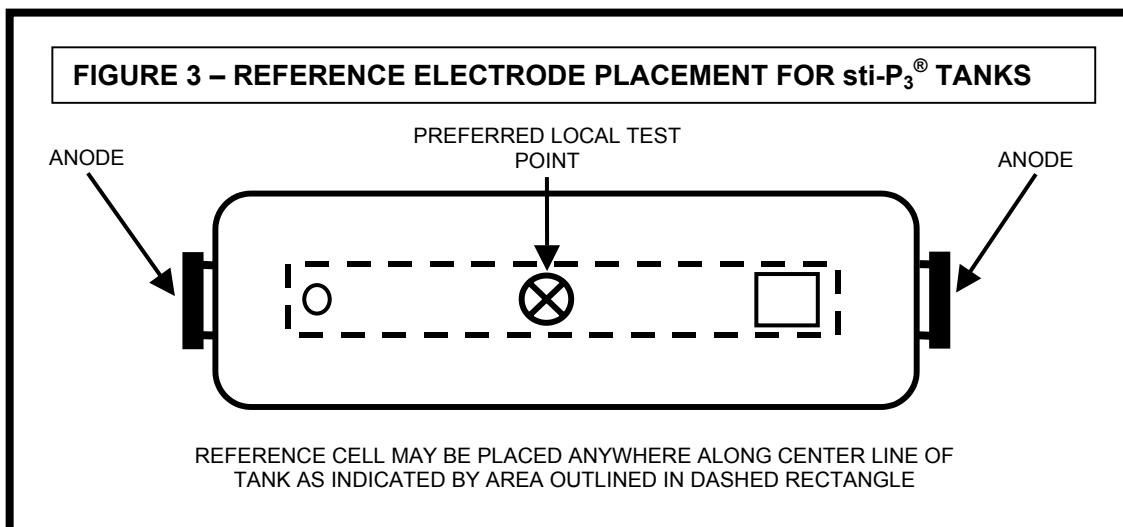

In addition to the local potential described above, a remote potential must also be obtained. Remote generally means the reference electrode is placed in the soil at least 25 feet away and not more than 100 feet away from the tank you are measuring (See Figure 4). Refer to Section 6.8.3 for a more complete discussion of remote reference electrode placement.

Care must be taken that the remote location is not in proximity to any other cathodically protected structure (e.g. natural gas lines) or directly over any other kind of buried metallic structure. The remote placement should be such that the reference electrode is aligned with the longitudinal axis of the tanks and can "see" the anodes. This orientation is desirable in order to prevent shielding.

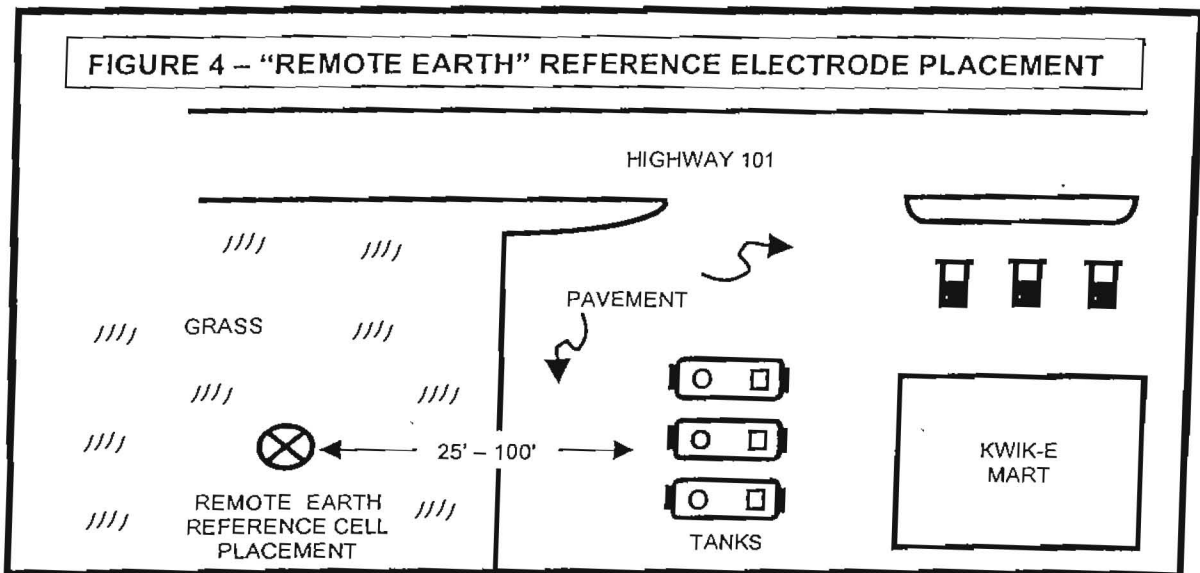

6.10.2 Galvanically Protected Metallic Piping

Both local and remote potentials are required on all galvanically protected metallic piping. When metallic piping is protected by sacrificial anodes, several different possibilities exist as to where would be the appropriate location to place the reference electrode to obtain local potentials. Knowing where the anodes that are protecting the piping are installed is of critical importance. When obtaining local potentials, the reference electrode must be placed in the soil directly over the pipe to be evaluated at a point that is the most distant from any anode that may be along the pipe.

Because it is a common practice to bury piping anodes at the submersible pump manway of a tank, the appropriate location to place the reference electrode to obtain local potentials is at the dispensers (See Figure 5). Remote placement of the reference electrode is also necessary.

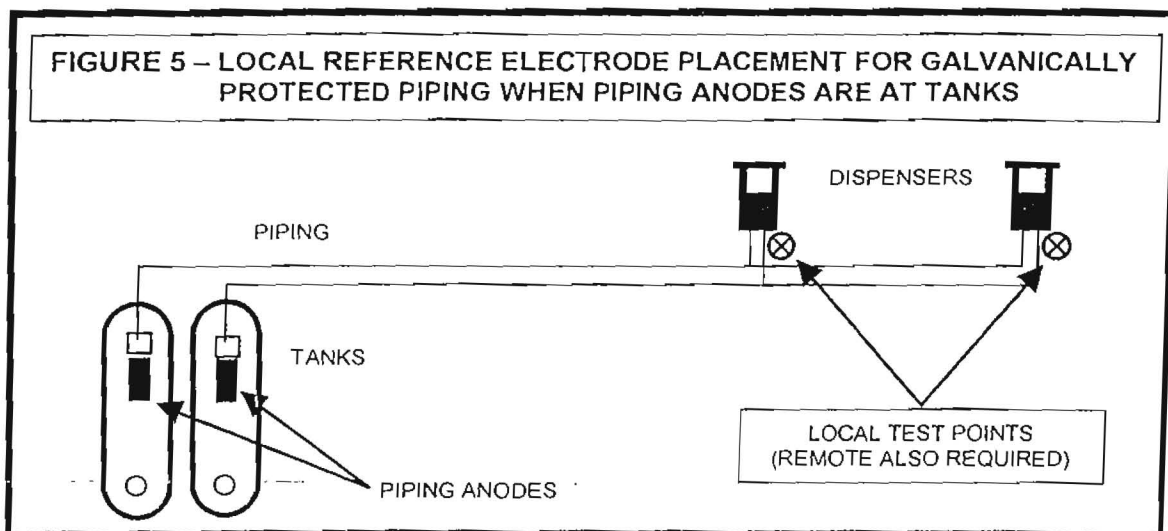

When the piping anodes are installed at the dispensers, the appropriate local reference electrode placement would be at the piping nearest the tanks (usually the submersible turbine pump manway) as shown in Figure 6. Remote placement of the reference electrode is also necessary.

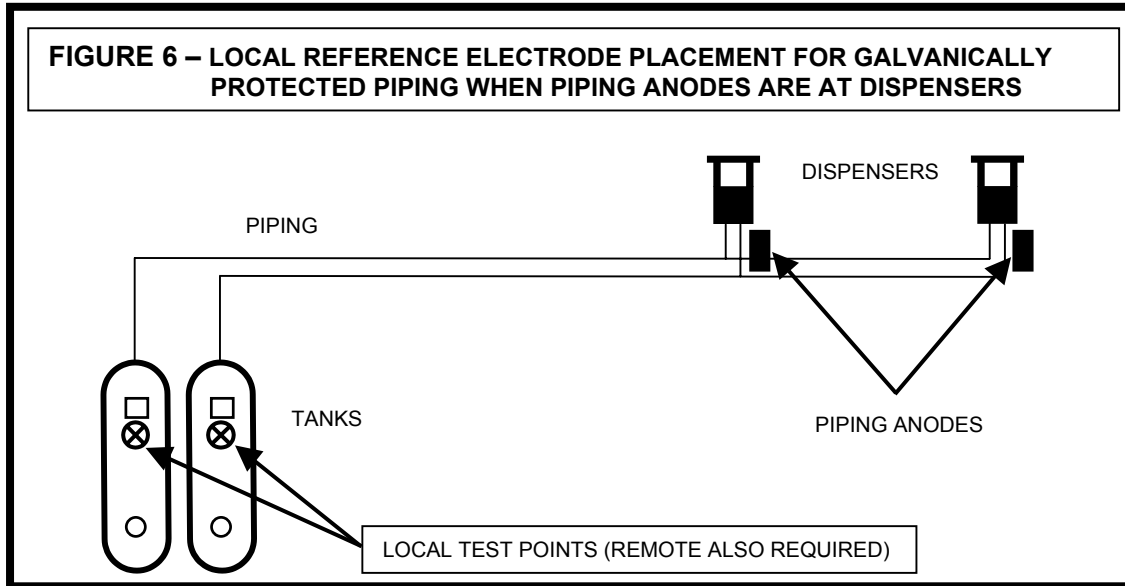

When the piping anodes are located at both the tanks and the dispensers, the reference electrode must be placed at the approximate center of the piping run to obtain local potentials (See Figure 7). Remote placement of the reference electrode is also necessary.

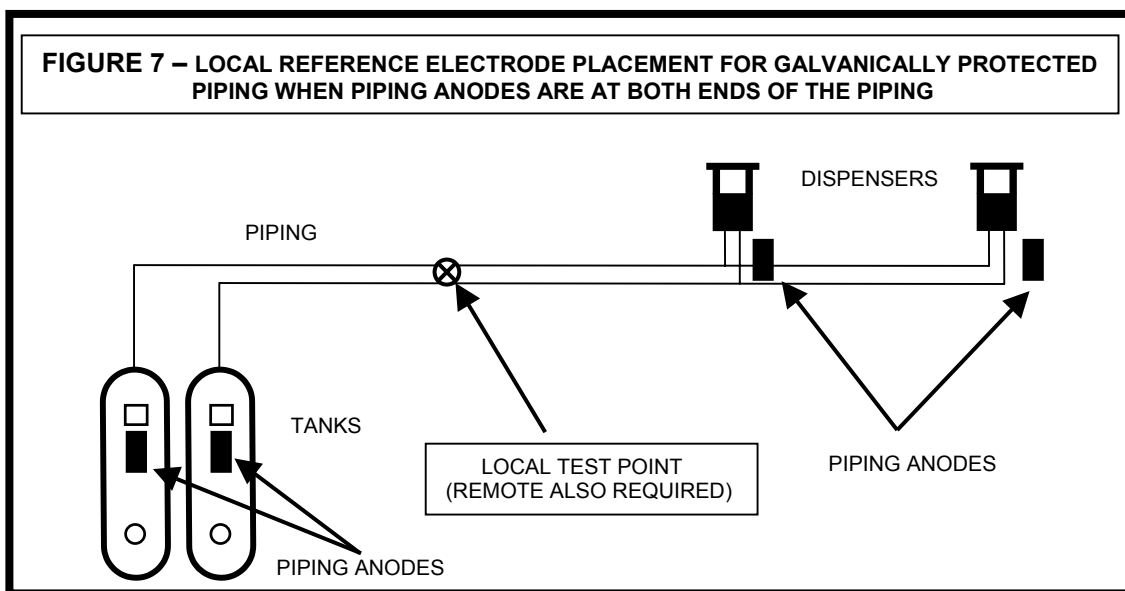

When the anodes are installed at the center of the piping, or it is not known where the anodes are installed, the reference electrode must be placed at both the tank and the dispenser end of the piping to obtain local potentials (See Figure 8). Remote placement of the reference electrode is also necessary.

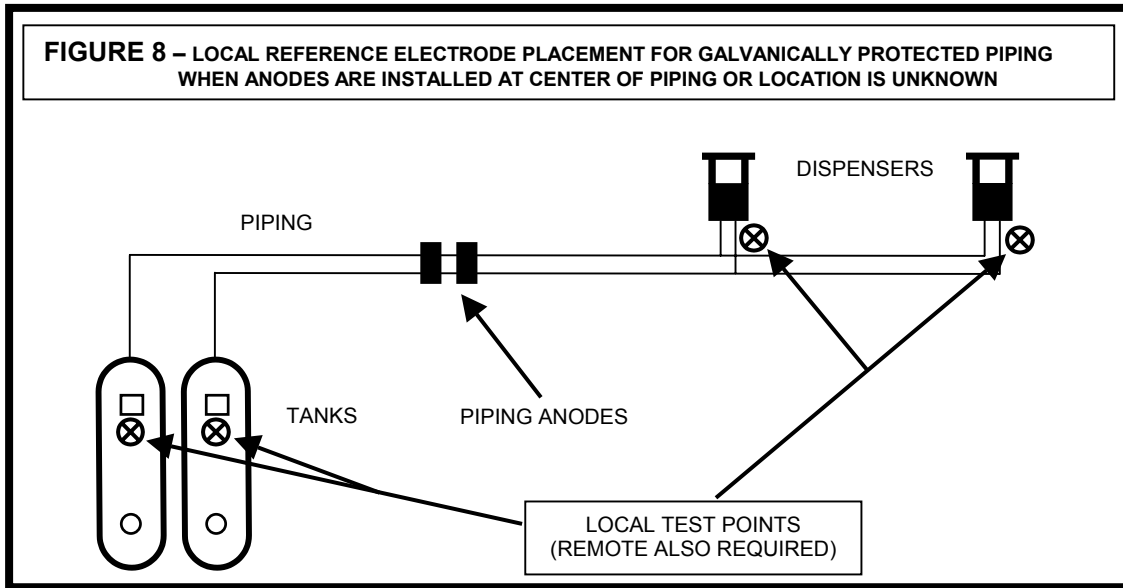

6.10.3 Tanks Protected by Impressed Current

With impressed current cathodic protection systems, tank potentials are required to be measured with the reference electrode placed locally. Where the location of the anodes is known and they are relatively evenly distributed about the tank bed, the appropriate location to place the reference electrode would be in the soil at the middle of the tank (See Figure 9). However, if access to the soil is not available at the middle of the tank, the reference electrode may be placed in the soil at any point along the centerline of the tank similar to that described in Section 6.10.1.

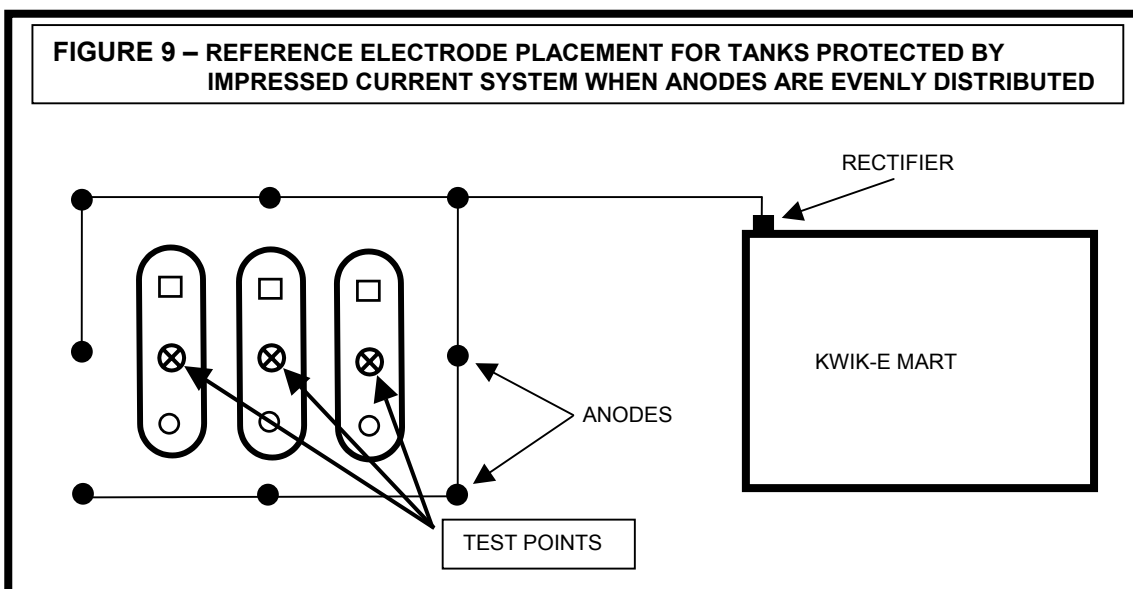

As with the evaluation of any cathodic protection system, the location of the anodes in relation to reference electrode placement can be of critical importance. When selecting the appropriate local placement, it is necessary to place the reference electrode at the point over the structure that is the most distant from any active anode due to the effects of attenuation. Attenuation of the cathodic protection current may occur whereby effective protection is not achieved at some point along a UST system. For instance, if all of the active anodes are along one side of a tank bed, current distribution and attenuation may prevent sufficient protective current from reaching the side of the tanks away from the anodes. The preferred placement of the reference electrode would be along the centerline of the tanks at the end opposite to that where the anodes are installed (See Figure 10).

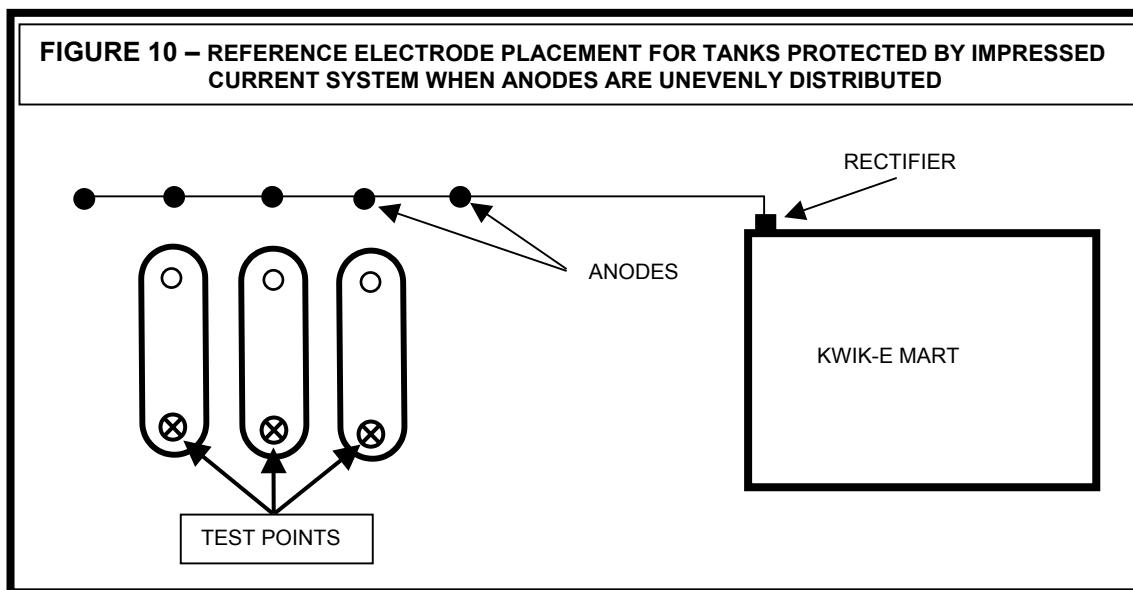

If it is not known where the anodes are installed, at least one measurement is required along the centerline of the tank. Testing should be conducted at as many locations along the centerline of the tank as are available. If soil access is available at each end of the tank and in the middle, all three structure-to-soil potentials should be recorded. If any one of the measured potentials does not meet one of the acceptable criteria, the structure should be failed.

In addition, if it is possible to measure the individual circuits in an impressed current system, a determination can be made as to which anodes are functional and how the current is distributed throughout the groundbed. How the current is distributed should be considered when choosing reference electrode placement when conducting a structure-to-soil potential survey. If for instance it is known that the majority of the rectifier output current is directed to only those anodes along one end of a tank bed, the reference electrode should be placed at the opposite end of the tank bed.

6.10.4 Piping Protected by Impressed Current

With impressed current cathodic protection systems, pipe potentials are required to be measured with the reference electrode placed locally. Just as with any other type of cathodic protection system, knowing where the anodes that are protecting the piping are installed is of critical importance. Due to the high degree of variability that exists in anode placement and piping configurations, structure-to-soil potentials must be obtained by placing the reference electrode at both the tank and dispenser end of any piping that is protected by impressed current (See Figure 11).

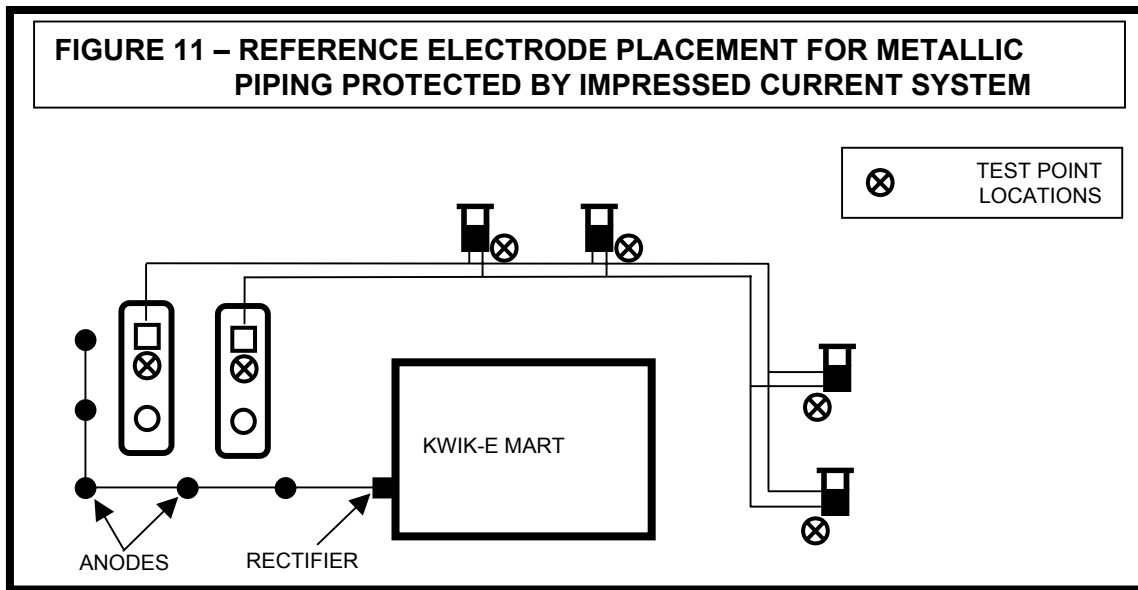

6.10.5 “100 Foot Rule” for Piping

For both galvanic and impressed current systems, if more than 100 feet of piping exists between any two anodes, the reference electrode must also be placed at the midpoint between the two anodes that are separated by more than 100 feet (see Figure 12). In addition, if it is not known where the piping anodes are located, there can be no more than 100 feet of piping between any two test points. This midpoint placement is in addition to any other reference electrode placement that may be required as noted above in Sections 6.10.1 through 6.10.4.

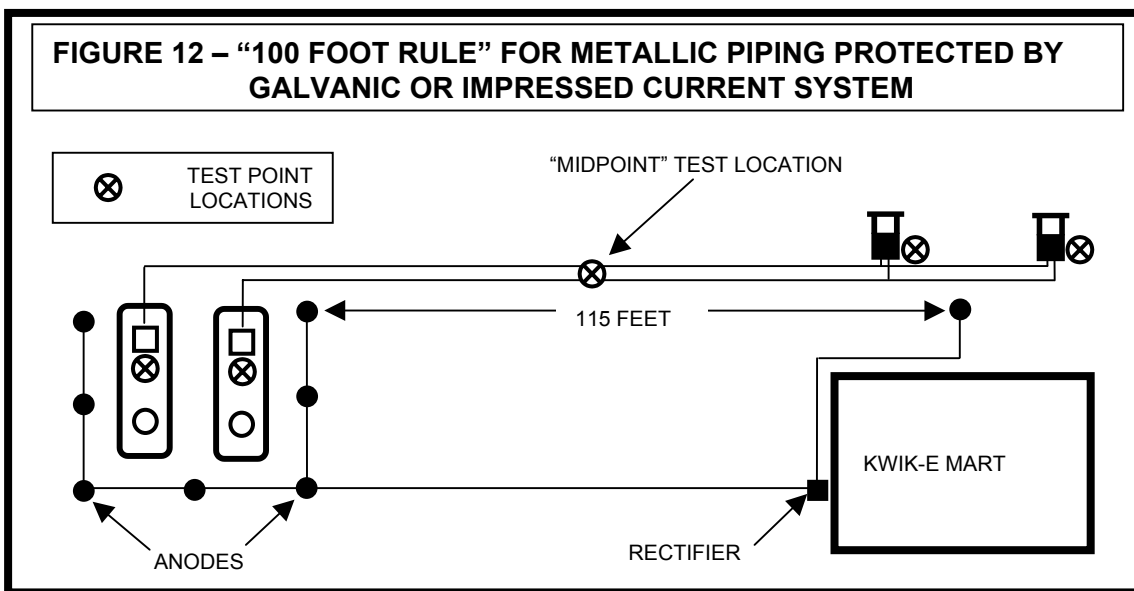

SECTION 7 - DOCUMENTATION OF EVALUATION

7.1 Documentation

As with any kind of testing or work that is being performed at a UST facility, it is critical that proper documentation be made of all activities and test procedures. Without proper documentation, the evaluation of a cathodic protection system through the application of a structure-to-soil potential survey is of little value.

Although it has been previously stated, the exact location where the reference electrode was placed in order to obtain a passing structure-to-soil potential is of critical importance and cannot be overemphasized. For this reason, an exact description of where the reference electrode was placed for each structure-to-soil potential obtained during the survey is an absolute necessity. Failure to properly document reference electrode placement will result in the survey being deemed invalid.

Additionally, in order to effectively evaluate the survey of a cathodic protection system it is essential to be able to clearly understand how the survey was conducted. Likewise, when a re-survey of an existing system is being conducted it is important that the tester understands how the previous survey was conducted. Various forms of documentation may be necessary in order to clearly convey the procedures and survey results. In the sections that follow, some of the more critical aspects of documentation are discussed in more detail.

7.1.1 As Built Drawings

If any modification to the construction of the cathodic protection system is made (e.g. supplemental anodes) it is necessary to show the modification on the "as built" drawings. If no as built drawing is available, you must indicate the location of any anode addition on the site drawing that is constructed as part of the evaluation. As built drawings are required whenever a cathodic protection system is installed or substantially modified. The drawings should include: a) how many anodes were installed; b) what type of anodes were installed; c) where were the anodes installed; d) how deep were the anodes installed; e) what type of wire was used; f) how were the wires bonded, etc.

7.1.2 Site Drawing

Whenever a cathodic protection survey is conducted, a site drawing depicting the UST system, the cathodic protection system and any related features of the facility must be constructed. In addition, you must indicate on the drawing where the reference electrode was placed for each of the structure-to-soil potentials utilized to obtain a pass. Figure 13 is an example of a site drawing that shows the type of information that is necessary to properly complete the evaluation.

While it is understood that you will not always know where all of the pertinent components of the cathodic protection system may be buried, all that is known must be indicated. It is very important to show where the anodes are located on the site drawing. If you do not know where the anodes are buried, voltage gradients in the soil may help you determine the approximate location as described in the raised earth discussion of Section 6.3.

Should any modifications to the cathodic protection system be made, it is very important that such modifications be both visually indicated on the site drawing and a written narrative made that describes the work conducted. If as built drawings are available, it is acceptable to utilize these drawings for the purposes of meeting the requirements of this section. Any modifications or changes to the UST and/or cathodic protection systems that have been made since the construction of the as built drawings must be included.

FIGURE 13 – EXAMPLE OF A SITE DRAWING CONSTRUCTED AS PART OF A UST SYSTEM CATHODIC PROTECTION SURVEY

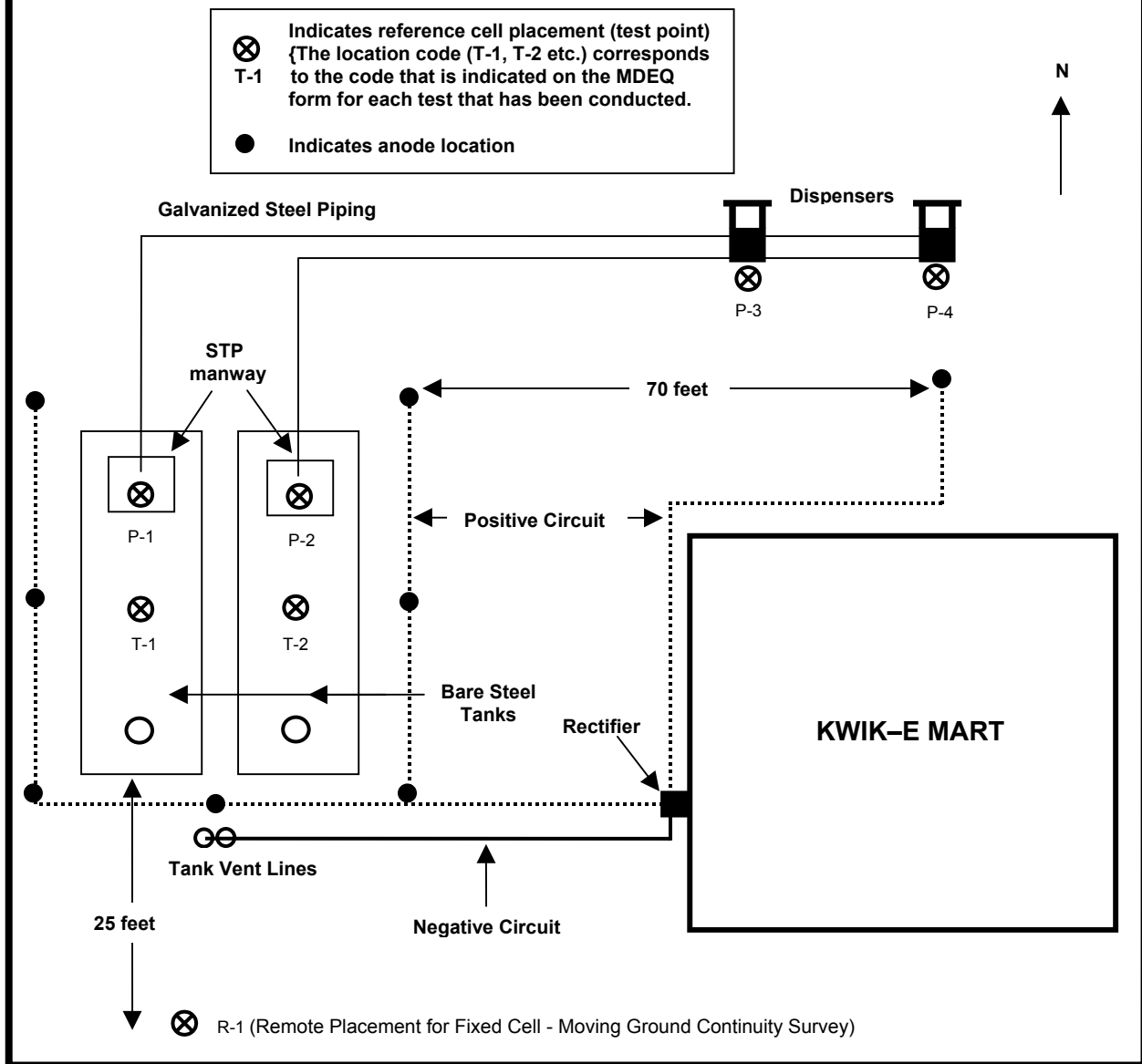

7.1.3 MDEQ UST Cathodic Protection Evaluation Forms

Whenever a cathodic protection survey is conducted in the State of Mississippi, the appropriate form (s) prescribed by the MDEQ (Appendix K and/or L) must be utilized to document the survey. However, use of the prescribed form(s) is not intended to limit other kinds of documentation that may be desirable in order to complete the evaluation. For instance, it may be necessary to provide a written narrative describing various aspects of the evaluation or a repair/modification that are not captured by completion of the form(s) themselves.

7.1.4 Pass/Fail/Inconclusive

In order to assure uniformity in the manner in which cathodic protection evaluations are documented, it is necessary to "make a call" as prescribed in the MDEQ cathodic protection evaluation form found in Appendix K and L of this document. The terms "pass", "fail" and "inconclusive" are utilized for this purpose. Therefore, it is necessary to clarify what these terms mean and their applicability as related to the evaluation of cathodic protection systems utilizing the MDEQ forms.

An evaluation conducted by an individual who is only qualified as a cathodic protection tester must result in one of three conclusions, pass, fail or inconclusive. If the person conducting the evaluation is qualified as a corrosion expert, the evaluation must result in either pass or fail.

Pass - The term "pass" as related to Section VI and VII (tester's/corrosion expert's evaluation) of the MDEQ galvanic/impressed current cathodic protection system evaluation forms is taken to mean that the structure-to-soil potential survey indicates all of the protected structures at a facility meet at least one of the three accepted criteria.

Pass as related to Section XIV and XVI (potential survey) of the respective MDEQ galvanic/impressed current cathodic protection system evaluation forms means that the individual structure that is being tested meets at least one of the accepted criteria.

Fail - The term "fail" as related to Section VI and VII (tester's/corrosion expert's evaluation) of the MDEQ galvanic/impressed current cathodic protection system evaluation forms means that the structure-to-soil potential survey indicates that there are one or more protected structures at a facility that do not meet any of the accepted criteria.

Fail as related to Section XIV and XVI (potential survey) of the respective MDEQ galvanic/impressed current cathodic protection system evaluation forms means that the individual structure that is being tested does not meet any of the accepted criteria.

Inconclusive - The term "inconclusive" as related to Section VI (tester's evaluation) of the MDEQ galvanic/impressed current cathodic protection system evaluation forms means that a person qualified only as a tester is unable to conclusively evaluate the cathodic protection system and a corrosion expert must "make the call". A cathodic protection tester must indicate inconclusive whenever one or more of the conditions listed in Section 7.2 of this document are applicable.

Inconclusive as related to Section XII and XV (continuity testing) of the respective MDEQ galvanic/impressed current cathodic protection system evaluation forms means that it cannot be determined if the individual structure that is being tested is either electrically isolated in the case of galvanic systems or is electrically continuous in the case of impressed current systems.

Inconclusive as related to Section XIV of the MDEQ galvanic cathodic protection system evaluation form is utilized when both the local and the remote potential measurements do not result in the same conclusion. If for instance the local potential was -900 mV but the remote was -700 mV an inconclusive would result since the local indicates that adequate cathodic protection is provided but the remote does not.

7.2 Corrosion Expert's Evaluation

Because the MDEQ has allowed those individuals who may only have minimal training in the principles of cathodic protection to conduct testing of such systems, it must be recognized that

there will be instances where the expertise of someone who is more qualified and better understands the principles involved will be necessary.

Some of the more obvious scenarios where a person with a level of expertise equivalent to a “corrosion expert” {as defined in Section 2.1 (280.12) of this document} are necessary are given below. If any of the conditions given below are met, a corrosion expert must evaluate the survey results obtained by a tester and/or conduct further testing and complete Section VII of the MDEQ cathodic protection system evaluation form(s). If the structure-to-soil potential survey is conducted by a person who is qualified as a corrosion expert, completion of Section VII of the MDEQ form(s) is all that is necessary.

A corrosion expert is required to evaluate and/or conduct the survey when:

1. Supplemental anodes are added to a galvanic cathodic protection system and an accepted industry standard is not followed and/or properly documented.
2. Supplemental anodes or other changes in the construction of an impressed current system are made.
3. It is known or suspected that stray current may be affecting the protected structure.
4. The repair and/or addition of supplemental anodes to bare steel/galvanized piping that is galvanically protected (see Section 5.1.3).
5. An inconclusive was declared when testing a galvanically protected structure because both the local and the remote potentials did not indicate the same result (one indicated pass but the other indicated fail).

Although not specifically listed above, it should be recognized that there might be additional circumstances that may arise that will require evaluation, and/or design by a corrosion expert.

7.3 What if the Evaluation Result is Fail?

It is important to properly notify the tank owner if an evaluation of the cathodic protection system fails. Necessary repairs should be accomplished within 90 days of receipt of the “failed” evaluation. The tank owner is responsible for ensuring that the cathodic protection system is maintained in a manner that will provide adequate corrosion protection to the UST system.

As it is recognized that many factors may cause a lower than desired voltage to be obtained during a structure-to-soil survey, there may be several different courses of action appropriate to resolve the “fail”. For instance, it is not uncommon to simply retest a sti-P₃[®] tank that has failed a cathodic protection survey at a later date and achieve a passing result.

Therefore, a 90-day re-testing period is allowed whenever a fail is obtained during which no action is necessary to repair or modify the cathodic protection system. This applies only to those galvanic and impressed current systems that appear to be in good working condition. If there are obvious problems with a system or you are unable to achieve a pass within the 90-day window, the tank owner must make any repairs and/or modifications that are necessary to achieve a pass. Repairs and/or modifications must be completed as soon as practical but no more than 90 days should be allowed after expiration of the “90 day window”.

APPENDIX A - INDUSTRY CODES/STANDARDS, REFERENCES and REGULATIONS

INDUSTRY CODES/STANDARDS

American Petroleum Institute (API) RP1632 3rd Edition "Cathodic Protection of Underground Petroleum Storage Tanks and Piping Systems".

American Petroleum Institute (API) RP1615 5th Edition "Installation of Underground Petroleum Storage Systems".

National Association of Corrosion Engineers (NACE International) RP0169-96 "Control of External Corrosion on Underground or Submerged Metallic Piping Systems".

National Association of Corrosion Engineers (NACE International) TM0101-2001 "Measurement Techniques Related to Criteria for Cathodic Protection on Underground or Submerged Metallic Tank Systems".

National Association of Corrosion Engineers (NACE International) RP0285-2002 "Corrosion Control of Underground Storage Tank Systems by Cathodic Protection".

Petroleum Equipment Institute (PEI) RP 100-2000 "Recommended Practices for Installation of Underground Liquid Storage Systems".

Steel Tank Institute (STI) R892-91 "Recommended Practice for Corrosion Protection of Underground Piping Networks Associated with Liquid Storage and Dispensing Systems".

Steel Tank Institute (STI) R972-01 "Recommended Practice for the Installation of Supplemental Anodes for sti-P₃[®] UST's".

REFERENCES

Department of Defense MIL-HDBK-1136 "Maintenance and Operation of Cathodic Protection Systems".

Department of Defense MIL-HDBK-1136/1 "Cathodic Protection Field Testing".

REGULATIONS

Subtitle I of the Resource Conservation and Recovery Act published in the Code of Federal Regulations Chapter 40 Part 280 "Technical Standards and Corrective Action Requirements for Owners and Operators of Underground Storage Tank Systems".

APPENDIX B – GLOSSARY

100 mV POLARIZATION – One of the three criteria that are commonly accepted as indicating adequate cathodic protection has been achieved. It is typically measured by interrupting the protective current on an impressed current system. When the current is interrupted, an “instant off” potential is recorded and the structure under cathodic protection is then allowed to depolarize until a change of at least 100 mV in potential is observed. Not more than 24 hours should be allowed for the depolarization to occur when conducting this test.

850 ON – One of the three criteria that are commonly accepted as indicating adequate cathodic protection has been achieved. It is measured with the protective current applied and is typically the only measurement possible with galvanic systems since the anodes cannot be disconnected. This criterion is not applicable to impressed current systems since a large portion of the “on” measurement can be comprised of a voltage drop when the protective current is applied.

850 OFF - One of the three criteria that are commonly accepted as indicating adequate cathodic protection has been achieved. It is measured with the protective current interrupted (either the power is cut off to the rectifier or the sacrificial anodes are disconnected). This criterion is considered by most to be the best indicator that adequate cathodic protection has been provided.

ANODE – The electrode of an electrochemical cell where oxidation (corrosion) occurs. With respect to cathodic protection, it can be thought of as the place where electrons leave the surface of a metal. Common galvanic anodes are zinc and magnesium.

AMPERE (AMP) – The basic unit of current flow in an electric circuit. Amperage can be thought of as “gallons per minute” in a water system.

AS BUILT DRAWINGS – Drawings that show how a system was actually installed in the field. Sometimes, unforeseen factors prevent the installation of a system as it was intended in the design drawings and this is why it is important to have detailed and accurate “as built” drawings.

ATTENUATION - The protective effects of cathodic protection current diminish as you move away from the source of the protective current. To illustrate this, on an impressed current system where the ground bed is installed only on one side of the tank bed, the end of the tanks away from the ground bed will receive less protective current than the side of the tanks closest to the anodes. Attenuation of protective current applies to galvanic systems as well.

CATHODE – The electrode of an electrochemical cell where reduction (and no corrosion) occurs. With respect to cathodic protection, it can be thought of as the place where current enters the surface of a metal.

CATHODIC PROTECTION – The technique of causing the entire surface of a metallic structure to become a cathode with respect to its external environment (soil). This is accomplished by supplying an electric current sufficient to overcome the tendency of naturally occurring electrical currents to leave the metallic structure.

CATHODIC PROTECTION EVALUATION – The interpretation of whether or not a cathodic protection system is providing sufficient corrosion protection. An evaluation incorporates all cathodic protection testing, surveys, rectifier operation/output measurements, consideration of voltage drops, condition of dielectric coatings, continuity, bond integrity, circuit integrity and any other factors or site specific conditions that may have an influence on the operation and effectiveness of a cathodic protection system.

CATHODIC PROTECTION SURVEY – Refers to the process whereby all of the structure-to-soil measurements necessary to contribute to the final evaluation of a system are obtained.

CATHODIC PROTECTION TEST – Refers to the process whereby only a single structure-to-soil measurement is obtained.

CONTINUITY – As related to cathodic protection, continuity means that two metallic structures are electrically continuous. With impressed current systems all protected structures must be continuous and this is normally accomplished through the use of wires referred to as continuity bonds.

CORROSION – The deterioration of a material (usually a metal) caused by an electro-chemical reaction with its environment. Corrosion of metals involves the flow of electrons (current) between an anode and a cathode. Corrosion will occur where the electrons leave the surface of a metal.

CURRENT TEST – A method of temporarily creating an impressed current cathodic protection system on a galvanically protected structure so that it can be determined how much protective current is necessary in order to achieve adequate cathodic protection. This is normally done by connecting a 12-volt battery to the structure to be tested and to a temporary anode.

DIELECTRIC MATERIAL – A coating that does not conduct electricity. Various coatings are utilized and some examples are the “fusion-bonded epoxy” found on factory coated steel piping and coal tar epoxies commonly found on sti-P₃[®] tanks.

DISTRIBUTED GROUND BED – Used to describe an anode configuration in which the anodes are more or less equally distributed around the metallic structure that is intended to be protected.

ELECTROLYTE – As related to UST cathodic protection systems, electrolyte refers to the soil and/or water surrounding the metallic structure that is under cathodic protection.

ELECTROMAGNETIC INTERFERENCE – As related to corrosion protection, it is an external electrical current that causes an error in a voltmeter measurement. Sources are commonly associated with high voltage AC power lines, radio frequency transmitters and airport radar systems.

FAIL – See Section 7.1.4.

FIELD INSTALLED – Refers to any impressed current system or sacrificial anode cathodic protection system that is installed at a pre-existing UST location or when sacrificial anodes are installed on new metallic pipe in the field. Any cathodic protection system except for those associated with unmodified sti-P₃[®] tanks may be thought of as “field installed”.

FINAL POTENTIAL (VOLTAGE) – The voltage that is observed at the end of the depolarization period associated with the measurement of “100 mV polarization”. The final voltage must be at least 100 mV less than the “instant off” voltage in order to meet the 100 mV polarization criterion for adequate cathodic protection.

“FIXED CELL – MOVING GROUND” – A technique for measuring continuity in a UST system whereby the reference electrode is placed in the soil at a location remote from the UST system and is left undisturbed (fixed cell) while potentials are measured on various parts of the UST system (moving ground).

GALVANIC (SACRIFICIAL) ANODE – A metal of high electro-potential (see Appendix J) that is used to protect another metal. Zinc and magnesium are two metals that are commonly utilized in the protection of UST systems.

GALVANIC CATHODIC PROTECTION – A cathodic protection system that utilizes sacrificial anodes to provide the protective current. The anode will corrode (sacrifice itself) instead of the metal it is intended to protect. The anode provides a protective current (reverses the electron flow) because it has a higher electrochemical potential than the metal it is intended to protect. Galvanic systems are normally limited to the protection of well coated structures because they have a very low driving potential.

IMPRESSED CURRENT ANODE – A metal that is utilized to deliver the current from a rectifier to the soil in order to protect the intended metallic structure. Impressed current anodes are commonly made of graphite, high silicon cast iron and “mixed-metal oxides” because the metal must be highly resistant to corrosion in order to have an acceptably long life span.

IMPRESSED CURRENT CATHODIC PROTECTION – A cathodic protection system in which the protective current is supplied by an external source (rectifier). The level of protective current that is delivered to the structure is adjustable and is much higher than that associated with galvanic anodes. For this reason, impressed current systems are utilized on those UST systems that are uncoated or require a high amount of protective current.

INCONCLUSIVE - See Section 7.1.4.

INSTANT OFF POTENTIAL (VOLTAGE) – The voltage that is observed momentarily after the power to an impressed current cathodic protection system is interrupted. It is used as the base line from which to begin calculating a “100 mV polarization”. The second number that appears after the current is interrupted is considered the proper value to represent the instant off potential.

ISOLATION – As related to cathodic protection, isolation means that two metallic structures are electrically discontinuous. With galvanic systems a protected structure must be electrically isolated and this is normally accomplished through the use of nylon bushings and dielectric unions.

LOCAL POTENTIAL (VOLTAGE) – The structure-to-soil potential of a metallic structure that is measured with the reference electrode placed in the soil immediately over the protected structure.

NACE INTERNATIONAL – Acronym for National Association of Corrosion Engineers International.

NATIVE POTENTIAL (VOLTAGE) – The structure-to-soil potential exhibited before any cathodic protection is applied.

ON POTENTIAL (VOLTAGE) – The structure-to-soil potential that is measured with the protective current applied.

PARALLEL CIRCUIT – Can be caused by the person conducting the test making contact with a metallic part of the test leads, or reference electrode when conducting structure-to-soil potential measurements. The creation of parallel paths must be avoided since inadvertent errors can be introduced.

PASS – See Section 7.1.4

PASSIVATION - When a metal undergoes passivation, an oxidation layer forms on the surface of the metal due to corrosion and can be defined as the loss of chemical reactivity. The oxidation layer acts as a coating and prevents or slows further corrosion of the metallic object since oxygen is prevented from reaching the underlying metal.

PHOTOVOLTAIC EFFECT – Sunlight striking the electrolyte solution in a copper-copper sulfate reference electrode can cause an error in the observed structure-to-soil potential and must be avoided.

“POINT-TO-POINT” - A technique for measuring continuity in a UST system whereby each lead of a voltmeter is connected to the two metallic structures of interest (negative lead to one structure and positive to the other). The voltage difference (if any) measured with the voltmeter connected in this manner indicates if continuity is present or not.

POLARIZATION – The change in the structure-to-soil potential of a metallic structure due to the application of a protective current. In this guidance document, polarization is considered to mean cathodic polarization - that is, the potential of the metal is shifted in the negative direction.

POLARIZED POTENTIAL – The structure-to-soil potential of a metallic structure that is observed after the protective current is applied and sufficient time has elapsed for the structure to completely polarize.

RAISED EARTH – Term used to describe the high voltage gradient found in the soil around an active impressed current or sacrificial anode. Placement of the reference electrode in proximity to an active anode will cause an abnormally high (more negative) structure-to-soil potential than would be present if the anode were not in close proximity.

RECTIFIER – A device utilized in impressed current systems that changes AC power to DC power.

REFERENCE ELECTRODE – Also referred to as a reference cell or a half-cell. A device whose electrochemical potential is constant that is used to measure the structure-to-soil potential of buried metallic structures. The potential that is observed on the buried metallic structure is relative to the potential of the reference electrode. The potential of a buried metallic structure would be zero if it were of the exact same composition as the reference electrode if all sources of measurement error were eliminated.

RESISTANCE – A measurement of the tendency of a substance to inhibit the flow of electrical current. Resistance in UST cathodic protection systems is generally meant to refer to the electrical properties of the backfill materials (soil).

REMOTE EARTH – The structure-to-soil potential of a metallic structure that is measured with the reference electrode placed in the soil at a point well away (remote) from the protected structure. Remote earth is generally thought of as at least 25 feet and not more than 100 feet away. Remote earth is established when the observed structure-to-soil potential does not significantly change no matter how far away the reference electrode is from the protected structure.

SACRIFICIAL ANODE – See Galvanic Anode.

SHIELDING – A structure that prevents or diverts an electrical current from reaching the desired location. Normally thought of as something that stops a reference electrode from being able to “see” the metallic structure that you trying to measure.

sti-P₃[®] TANK – A steel tank manufactured to the standard created by the Steel Tank Institute that comes from the factory with a “pre-engineered” cathodic protection system. The “P3” means that the steel tank is protected in three ways: 1) A protective dielectric coating is factory applied; 2) Sacrificial anodes (normally zinc) are factory installed on the tanks and 3) dielectric bushings are installed to facilitate electrical isolation of the tank.

STRAY CURRENT – An electrical current that travels along an unintended path. Normally thought of as a current from some external source that enters a protected metallic structure at one point that then exits at another point. The point where the stray current exits the protected structure can be subject to intense corrosion and failure may rapidly occur.

STRUCTURE-TO-SOIL POTENTIAL – Also know as “pipe-to-soil potential” or “structure-to-electrolyte potential” – The difference in the potential of the surface of a buried metallic structure and the electrolyte (soil) that surrounds it with respect to a reference electrode in contact with the electrolyte (soil). Can be thought of as the voltage difference between a buried metallic structure and the soil that it is buried in.

VOLTAGE – The basic unit of force in an electric circuit. Voltage is equivalent to pounds per square inch in a water system.

VOLTAGE (IR) DROP – With respect to UST cathodic protection systems, voltage drops may be thought of as any voltage that causes an error in the observed structure-to-soil potential. Whenever a current is flowing through a resistance, a voltage drop is present and is part of the voltage measurement obtained.

APPENDIX C

GENERALIZED INTERPRETATION OF STRUCTURE-TO-SOIL POTENTIAL MEASUREMENTS (VOLTAGES) OBTAINED ON GALVANIC CATHODIC PROTECTION SYSTEMS	
Listed in this table are some generalized observations that can be applied to the interpretation of structure-to-soil potentials. Depending on the specific site conditions and other factors, differing interpretations are possible.	
VOLTAGE (mV) "ON"	GENERALIZED INTERPRETATION
POSITIVE	Test leads are reversed (negative should be connected to the reference electrode and the positive should contact the structure you are testing in order to observe negative voltages). Could indicate that stray current is affecting the structure (consult with a corrosion expert).
0 to -100	Usually occurs when you are attempting to measure a structure that has a test lead that is not continuous with the tank. Because you are measuring the potential of a copper wire with reference to the copper-copper sulfate half-cell, the potential is zero or very near it. Disregard test lead and make direct contact with the protected structure.
-101 to -399	Try again – A reading in this range is not normally seen on an underground steel structure. Could indicate that steel structure is electrically connected to a significant amount of a more noble metal (e.g. copper). Very corroded low carbon steel may also be indicated.
-400 to -599	Steel structure does not meet regulatory requirements. Usually means that the steel structure has no cathodic protection. Existing sacrificial anodes could be completely "burned-out" or were never there to begin with.
-600 to -849	Steel structure does not meet regulatory requirements. Usually means that the steel structure has anodes but for whatever reason, something is causing a low reading that may indicate adequate cathodic protection has not been provided. The anodes may be trying to protect a structure that requires more current than they can produce. The protected steel structure may not be electrically isolated from all other metallic structures (conduct continuity testing). The environmental conditions may not be favorable at the time you are attempting to obtain the reading. Retest during the next 90 days to see if an acceptable reading can be obtained.
-850 to -1100	Steel structure protected by zinc anodes meets regulatory requirements and cathodic protection is judged to be adequate. Readings in this range are what you would expect on most sti-P ₃ [®] tanks that have not been modified and are reading "good" since nearly all come from the manufacturer with zinc anodes.
-850 to -1600	Steel structure protected by magnesium anodes meets regulatory requirements and cathodic protection is judged to be adequate. Readings in this range are what you would typically expect on steel piping that is reading "good" since magnesium anodes are generally installed on piping. You may also find readings up to -1600 mV on a sti-P ₃ [®] tank that has been retrofitted or was supplied at the factory with magnesium anodes.
MORE NEGATIVE THAN -1100 WITH ZINC ANODES ONLY	Voltages more negative than -1100 mV are theoretically not possible if there are only zinc anodes installed. If you have a reading more negative than -1100 mV and you are sure magnesium anodes are not present, you should suspect that stray current may be affecting the cathodically protected structure. A corrosion expert should be contacted immediately since stray current can cause a corrosion failure in a relatively short period of time.
MORE NEGATIVE THAN -1600	Voltages more negative than -1600 mV are theoretically not possible with any sacrificial anode cathodic protection system. If you have a reading more negative than -1600 mV on any galvanic cathodic protection system, you should suspect that stray current may be affecting the cathodically protected structure. A corrosion expert should be contacted immediately since stray current can cause a corrosion failure in a relatively short period of time.
VARIABLE	If the voltmeter readings vary you should suspect that stray current may be affecting the cathodically protected structure. Sometimes, the stray current can cause a pattern to develop that is recognizable. An example would be the on/off pattern of a nearby DC powered welding operation. A corrosion expert should be contacted immediately since stray current can cause a corrosion failure in a relatively short period of time.
RAPIDLY FLUCTUATING	If the voltmeter will not stabilize, it usually means that there is a high electrical resistance somewhere. Check all lead wires and connections and make sure that you are making a solid and clean metal to metal connection. Soil where the reference electrode is placed could be too dry. Add water to the soil or wait until a heavy rain occurs and try again. Petroleum contaminated soils may cause a high contact resistance. The tip of the reference electrode may need to be cleaned or replaced.

APPENDIX D

GENERALIZED INTERPRETATION OF STRUCTURE-TO-SOIL POTENTIAL MEASUREMENTS (VOLTAGES) OBTAINED ON IMPRESSED CURRENT CATHODIC PROTECTION SYSTEMS	
Listed in this table are some generalized observations that can be applied to the interpretation of structure-to-soil potentials. Depending on the specific site conditions and other factors, differing interpretations are possible.	
VOLTAGE (mV)	GENERALIZED INTERPRETATION
ANY POSITIVE VOLTAGE OR 0 TO -100 “ON” or “OFF”	Can indicate that the structure you are attempting to measure is not bonded to the impressed current system (conduct continuity testing). Stray current could be affecting the protected structure (consult a corrosion expert). Positive and negative wires could be reversed (negative must be to protected structure and positive to anode). Test leads are reversed (positive lead should contact structure and negative lead should be connected to reference electrode). Could indicate that you are measuring the potential of a copper wire.
-101 to -399 “ON” or “OFF”	Try again – A reading in this range is not normally seen on an underground steel structure. Could indicate that steel structure is electrically connected to a significant amount of a more noble metal (e.g. copper). Very corroded low carbon steel may also be indicated.
-400 to -599 “ON” or “OFF”	Usually means that the steel structure has no cathodic protection. Existing impressed current anodes could be completely “burned-out”. Continuity of anode lead wires (positive circuit) could be broken. Negative bonds on the protected structures may be broken or non-existent.
-600 to -849 “ON” or “OFF”	Usually means that the steel structure has some protection but for whatever reason, something is causing a low reading that may indicate adequate cathodic protection has not been provided. The impressed current system may be trying to protect a structure that requires more current than it can produce (rectifier output too small). The impressed current system may not be capable of effectively distributing the required current to all parts of the structure you are trying to protect (not enough anodes, anodes improperly installed, soil resistivity too high). The steel structure that is intended to be protected may not be electrically continuous with the other metallic structures under protection (conduct continuity testing). The environmental conditions may not be favorable at the time you are attempting to obtain the reading. Retest during the next 90 days.
-850 or MORE NEGATIVE “ON”	Steel structure may or may not be adequately protected. Usually indicates that the impressed current system is providing current to the structure although the reading normally includes a large voltage (IR) drop. Because the flow of current through the soil causes a voltage drop, the on potential cannot be used to indicate that adequate cathodic protection has been provided. Instant off potentials must be utilized to demonstrate cathodic protection.
-850 or MORE NEGATIVE “OFF”	Steel structure protected by impressed current system meets regulatory requirements and cathodic protection is judged to be adequate. A potential measurement of -850 mV or more negative with the protective current temporarily interrupted (850 off) is considered to be the best indicator that adequate cathodic protection has been provided.
MORE NEGATIVE THAN -1220 mV “OFF”	Instant off potentials more negative than -1220 mV are theoretically not possible. If you observe an instant off potential more negative than -1220 mV, you should suspect stray current is affecting the protected structure. Consult a corrosion expert immediately since stray current can cause a rapid corrosion failure of the protected structure.
MORE NEGATIVE THAN -2000 “ON”	Usually means that a high resistance exists in the ground bed that is causing a large voltage drop. This condition is normally evident by checking the rectifier output since the voltage is very high but the amperage is relatively low. However, you should be cautious when abnormally high voltages are observed since this can have a detrimental effect on cathodically protected structures or the anodes may be rapidly depleted. Stray current may also be generated that can adversely affect other buried metallic structures such as water lines and other utilities. Consult a corrosion expert whenever it is suspected that too much voltage is being generated.
VARIABLE “ON” or “OFF”	If the voltmeter readings vary, you should suspect that stray current may be affecting the cathodically protected structure. Sometimes, the stray current can cause a pattern to develop that is recognizable. An example would be the on/off pattern of a nearby DC powered welding operation. A corrosion expert should be contacted immediately since stray current can cause a corrosion failure in a relatively short period of time.
RAPIDLY FLUCTUATING “ON” or “OFF”	If the voltmeter will not stabilize, it usually means that there is a high electrical resistance somewhere. Check all lead wires and connections and make sure that you are making a solid and clean metal to metal connection. Soil where the reference electrode is placed could be too dry. Add water to the soil or wait until a heavy rain occurs and try again. Petroleum contaminated soils may cause a high contact resistance. The tip of the reference electrode may need to be cleaned or replaced.

APPENDIX E

CONTINUITY TESTING PROCEDURE FOR GALVANIC/IMPRESSED CURRENT CATHODIC PROTECTION SYSTEMS

Fixed Cell – Moving Ground Continuity Test Procedure

1. Place reference electrode in contact with the soil at a location remote (25 – 100 feet) from all cathodically protected structures. You must ensure that the remote reference electrode placement is not in proximity to any other cathodic protection systems (e.g. natural gas pipelines) or directly over any buried metallic structure in order to minimize the chances of unwanted interference.
2. Be sure that reference electrode is firmly placed in moist soil and is not in contact with any vegetation.
3. Connect reference electrode to the negative terminal of voltmeter using a long spool of suitable wire.
4. Connect positive lead wire to voltmeter. This lead wire should have a sharp test prod (scratch awl or similar) in order to assure good contact with the metallic structures under test.
5. Place voltmeter on 2 volt DC scale.
6. Contact each buried metallic structure with the positive test lead without moving the reference electrode. Typical items that would be tested during a continuity survey include: all tanks, tank risers, submersible pump heads, piping, flex connectors/swing joints, vent lines, electrical conduits, dispensers, utilities, etc.
7. Obtain voltage for each component and record on MDEQ continuity testing form.
8. Voltages for each component that is tested must be obtained as quickly as possible since the observed potential can change over time. This is because the conditions in the soil where the reference electrode is placed can change over a relatively short period of time.

Fixed Cell – Moving Ground Data Interpretation

- If two or more structures exhibit potentials that vary by 2 mV or less, the structures are considered to be electrically continuous.
- If two or more structures exhibit potentials that vary by 10 mV or greater, the structures are considered to be electrically isolated.
- If two or more structures exhibit potentials that vary by more than 2 mV but less than 10 mV, the result is inconclusive and further testing (point-to-point) is necessary.

Point-to-Point Continuity Test Procedure

1. Turn off power to rectifier if testing an impressed current system. This is necessary to obtain accurate results.
2. Connect test leads to voltmeter. Both test leads should have a sharp test prod or suitable clip lead in order to make good contact with tested structures.
3. Place voltmeter on 2 volt (or lower) DC scale.
4. Connect one voltmeter test lead to one of the structures for which continuity is being tested and connect the other voltmeter test lead to the other structure that is being tested.
5. Record voltages observed on each of the two structures that are being compared and record on MDEQ continuity testing form.

Note: Testing with this method does not require a reference electrode. The two structures of interest are simply connected in parallel with the voltmeter and a determination made as to whether or not any potential difference exists between them.

Point-to-Point Data Interpretation

- If the voltage difference observed between the two structures is 1 mV or less, this indicates that the two structures are considered to be electrically continuous with each other.
- If the voltage difference observed between the two structures is 10 mV or greater, this indicates that the two structures are considered to be electrically isolated from each other.
- If the voltage difference observed between the two structures is greater than 1mV but less than 10 mV, the result is inconclusive and further testing beyond the scope of this document is necessary.

APPENDIX F

STRUCTURE-TO-SOIL TEST PROCEDURE FOR GALVANIC CATHODIC PROTECTION SYSTEMS

1. Place voltmeter on 2 volt DC scale.
2. Connect voltmeter negative lead to reference electrode.
3. Place reference electrode in clean soil directly over the structure that is being tested to obtain local potential. At least one local potential is required for each tank - the preferred test point is at the approximate midpoint along the centerline of the tank. Piping may require measurement at each end of the pipe and at the middle depending upon anode configuration (see Section 6.10.2 of MDEQ guidance document).
 - The reference electrode may not be placed on concrete or other paving materials.
 - Ensure that the reference electrode is placed in a vertical position (tip down).
 - Ensure that the soil where the reference electrode is placed is moist – add tap water if necessary.
 - Ensure that the soil where the reference electrode is placed is not contaminated with hydrocarbons.
 - Ensure that the reference electrode window is not exposed to direct sunlight.
4. Connect voltmeter positive lead to structure that is to be tested.
 - If a test lead wire is utilized to make contact with the tested structure you must ensure that continuity exists between the test lead wire and the structure. This may be accomplished by conducting a point-to-point continuity test as described in Appendix E.
 - Ensure that good metal-to-metal contact is made between the test lead clip/probe and the structure.
 - Ensure that no corrosion exists where the test lead makes contact with the structure.
 - Ensure that your body does not come into contact with the electrical connections.
 - Ensure that test leads are not submerged in any standing water.
 - Ensure that test lead insulation is in good condition.
 - sti-P₃[®] tanks
 - If the test lead wire is not continuous or is not present, contact with the inside bottom of the tank is necessary. This may be accomplished by connecting the voltmeter lead wire to a test prod mounted onto the bottom of a wooden gauging stick and lowering the stick into the tank fill riser. Be sure that firm contact is made with the tank bottom. Care should be taken to ensure that any drop tube that may be installed in the tank does not prohibit contact with the tank bottom. If a metallic probe bar is utilized to contact the tank bottom, ensure that the probe bar does not contact the fill riser or any other metallic component of the UST system.
 - If a sti-P₃[®] tank is equipped with a PP4[®] test station, the PP4[®] test station is disregarded and potentials must be obtained with a portable reference electrode placed in the soil (both local and remote) as described in Section 6.10.1 of the MDEQ guidance document.
5. Obtain voltage and record in the local column on the MDEQ galvanic survey form.
6. Place reference electrode in clean soil remote from the protected structure. (Refer to Section 6.10.3 for a discussion of remote reference electrode placement.)
7. Obtain voltage and record in the remote column on the MDEQ galvanic cathodic protection form. (Note: if the fixed cell-moving ground method was used to conduct continuity survey, the potential obtained during the continuity survey for each corresponding structure may be transposed to the appropriate column.)

Data Interpretation (for a more complete discussion refer to Appendix C of this guidance document)

- If both the local and the remote potential are –850 mV or more negative, the 850 on criterion is satisfied and it is judged that adequate cathodic protection has been provided.
- If either the local or the remote potential is more positive than –850 mV the test result is inconclusive and further testing and/or repairs are necessary. Alternatively, a person qualified as a corrosion expert could evaluate/conduct the survey and declare a pass or fail based on their interpretation and professional judgement.

APPENDIX G

STRUCTURE-TO-SOIL TEST PROCEDURE FOR IMPRESSED CURRENT CATHODIC PROTECTION SYSTEMS

1. Inspect rectifier for proper operation and document necessary information. This includes measurement of output voltage/amperage with a multimeter (do not rely on rectifier gauges) and measurement of individual anode circuits (if installation allows such). Record all necessary information under Section XI and XII of MDEQ impressed current form.
2. Place voltmeter on 2 volt DC scale.
3. Connect voltmeter negative lead to reference electrode.
4. Place reference electrode in clean soil directly over the structure that is being tested. At least one measurement must be taken for each tank - the preferred test point is usually the center of the tank. Piping normally requires measurement at each end of the pipe (see Section 6.10.3 and 6.10.4 of MDEQ guidance document for further explanation).
 - The reference electrode may not be placed on concrete or other paving materials.
 - Ensure that the reference electrode is placed in a vertical position (tip down).
 - Ensure that the soil where the reference electrode is placed is moist – add tap water if necessary.
 - Ensure that the soil where the reference electrode is placed is not contaminated with hydrocarbons.
 - Ensure that the reference electrode window is not exposed to direct sunlight.
5. Connect voltmeter positive lead to structure that is to be tested.
 - Ensure that good metal-to-metal contact is made between the test lead clip/probe and the structure.
 - Ensure that no corrosion exists where the test lead makes contact with the structure.
 - Ensure that your body does not come into contact with the electrical connections.
 - Ensure that test leads are not submerged in any standing water.
 - Ensure that test lead insulation is in good condition.
6. Obtain voltage potential with the protective current applied and record in the on column on the MDEQ impressed current cathodic protection evaluation form.
7. Without moving reference electrode from the position it was in during step 6 above, obtain voltage potential with the protective current temporarily interrupted and record in the instant off column on the MDEQ impressed current cathodic protection form.
 - The instant off potential is the 2nd value that is observed on a digital voltmeter the instant the power is interrupted. The first number that appears immediately after power interruption must be disregarded. After the second number appears, a rapid decay (depolarization) of the structure will normally occur.
 - In order to obtain instant off potentials, a current interrupter or a 2nd person is necessary. If a current interrupter is not available, have the second person throw the power switch at the rectifier off for 3 seconds and then back on for 15 seconds. Repeat this procedure until you are sure an accurate instant off reading has been obtained.
8. Conduct 100 mV polarization decay if you are unable to obtain an instant off potential of -850 mV or more negative in step 7 above. (Note: While not a requirement of this guidance document, consideration should be given to adjusting the rectifier output until an instant off potential of -850 mV is achieved or the maximum safe output is reached.) It is only necessary to conduct 100 mV polarization where the lowest (most positive) instant off potential is observed on the UST system.
 - 100 mV of polarization is determined by leaving the power interrupted on the structure until a change of at least 100 mV in the structure-to-soil potential is observed. In calculating the 100 mV decay, the instant off potential obtained in Step 7 above is utilized as the starting point (e.g. if instant off = -800 mV, power must be left off until decayed to -700 mV).
 - Calculate voltage change by subtracting final (or ending) voltage from the instant off voltage and record these values in the appropriate columns on the MDEQ impressed current cathodic protection evaluation form.

Data Interpretation (for a more complete discussion refer to Appendix D of this guidance document)

- If the instant off potential is -850 mV or more negative, the 850 off criterion is satisfied and it is judged that adequate cathodic protection has been provided.
- If the instant off potential is more positive than -850 mV, the tank may or may not be adequately protected and a 100 mV polarization test is necessary.
- If the structure exhibits more than 100 mV polarization, the 100 mV polarization criterion is met and it is judged that adequate cathodic protection has been provided.
- If you are unable to meet either the 850 instant off or the 100 mV polarization criteria, it is judged that adequate cathodic protection has not been provided and repairs/modification are indicated. Alternatively, a person qualified as a corrosion expert could evaluate/conduct the survey and determine that cathodic protection is adequate based on their interpretation.

APPENDIX H

CHECKLIST FOR GALVANIC CATHODIC PROTECTION SYSTEM SURVEY

- Identified UST owner, UST facility, CP tester, tester's qualifications and reason for survey (complete Sections I – V of MDEQ galvanic cathodic protection form).
- Described UST and cathodic protection system (complete Section X of MDEQ galvanic cathodic protection form).
- Constructed site drawing depicting all pertinent components of the UST and cathodic protection systems at the facility (complete Section XII of MDEQ galvanic cathodic protection form).
- Reviewed any previous cathodic protection design/repair/testing data that may be available.
- Ensured soil access was available directly over each cathodically protected component at the facility (see Section 6.9.2 of MDEQ cathodic protection guidance document for discussion).
- Conducted continuity testing of all pertinent metallic components at the UST facility by the fixed remote – moving ground and/or the point-to-point method (complete Section XII of MDEQ galvanic cathodic protection form).
- Obtained local structure-to-soil potentials on every cathodically protected structure with the reference electrode placed in the soil directly over the structure under test (complete Section XIV of MDEQ galvanic cathodic protection form).
- Obtained remote potentials or transposed remote potentials obtained during continuity testing for every cathodically protected structure to appropriate column in Section XIV of MDEQ galvanic cathodic protection form.
- Indicated location (by code or other means) of reference electrode placement on site drawing for each structure-to-soil potential that was obtained during the survey.
- Described any repairs and/or modifications that were made to the cathodic protection system (complete Section XI of MDEQ galvanic cathodic protection form).
- Indicated whether or not each protected structure met the -850mV on criteria for both the local and remote reference electrode placement by indicating pass/fail/inconclusive in the appropriate column in Section XVI of the MDEQ galvanic cathodic protection form.
- If only qualified as a tester - indicated the results of the evaluation by marking either pass, fail or inconclusive in Section VI of MDEQ galvanic cathodic protection form.
- If only qualified as a tester - marked inconclusive if any of the conditions found in Section 7.2 of MDEQ cathodic protection guidance document were applicable to survey.
- If tester indicated inconclusive, either repairs were conducted or a corrosion expert evaluated/conducted the survey and completed Section VII of MDEQ galvanic cathodic protection form.
- If a corrosion expert conducted and/or evaluated the survey – indicated the results by marking either pass or fail in Section VII of MDEQ galvanic cathodic protection form.
- Indicated criteria that were applied to the evaluation by completion of Section VIII of the MDEQ galvanic cathodic protection form.
- Indicated action required as a result of the survey by marking either none, retest or repair & retest in Section IX of MDEQ galvanic cathodic protection form.
- Provided UST owner with any other type(s) of documentation that may be necessary in order to adequately describe the cathodic protection evaluation including the operating status and any repairs or recommendations and attached same to the MDEQ galvanic cathodic protection form.

APPENDIX I

CHECKLIST FOR IMPRESSED CURRENT CATHODIC PROTECTION SYSTEM SURVEY

- Identified UST owner, UST facility, CP tester, tester's qualifications and reason for survey (complete Sections I – V of MDEQ impressed current cathodic protection form).
- Described UST system and type of cathodic protection (complete Section X of MDEQ impressed current cathodic protection form).
- Constructed site drawing depicting all pertinent components of the UST and cathodic protection systems at the facility (complete Section XIV of MDEQ impressed current cathodic protection form).
- Reviewed any previous cathodic protection design/repair/testing data that may be available.
- Checked rectifier for proper operation and measured output voltage/amperage with portable multimeter and indicated all other pertinent information (complete Section XI of MDEQ impressed current form).
- Measured current output of all positive and negative circuits if the system was designed to allow for such (complete Section XII of the MDEQ impressed current cathodic protection form).
- Ensured soil access was available directly over each cathodically protected component at the facility.
- Conducted continuity testing of all pertinent metallic components at the UST facility by the fixed remote – moving ground and/or point-to-point method (complete Section XV of MDEQ impressed current form).
- Recorded native structure-to-soil potentials in appropriate column in Section XVI of MDEQ impressed current cathodic protection form if this data was available or the system had been down long enough for complete depolarization to occur.
- Obtained structure-to-soil potential on every cathodically protected structure with the reference electrode placed in the soil directly over the structure under test with the protective current applied (on) and recorded voltages in appropriate column in Section XVI of MDEQ impressed current cathodic protection form.
- Obtained structure-to-soil potential on every cathodically protected structure without moving reference electrode from placement utilized to obtain on potential with the protective current temporarily interrupted (instant off) and recorded voltages in appropriate column in Section XVI of MDEQ impressed current form).
- Conducted 100 mV polarization test if all protected structures did not meet the -850 instant off criterion. Obtaining a 100 mV decay is only required on that component of the UST system that displays the lowest (most positive) instant off potential in order to demonstrate the criterion has been satisfied.
- Indicated location (by code or other means) of reference electrode placement on site drawing for each structure-to-soil potential that was obtained.
- Described any repairs and/or modifications that were made to the cathodic protection system (complete Section XIII of MDEQ impressed current cathodic protection form).
- Indicated whether or not each protected structure met the -850mV instant off criteria and/or the 100 mV polarization criteria by indicating pass/fail in the appropriate column in Section XVI of the MDEQ form.
- If only qualified as a tester - indicated the results of the evaluation by marking either pass, fail or inconclusive in Section VI of MDEQ impressed current cathodic protection form.
- If only qualified as a tester - marked inconclusive if any of the conditions found in Section 7.2 of MDEQ cathodic protection guidance document were applicable to survey.
- If it was necessary for the tester to indicate inconclusive, a corrosion expert evaluated the data obtained by a tester and/or conducted his own testing and completed Section VII of MDEQ impressed current form.
- If a corrosion expert conducted evaluation – indicated the results by marking either pass or fail in Section VII of MDEQ impressed current cathodic protection form.
- Indicated criteria that were applied to the evaluation by completion of Section VIII of the MDEQ form.
- Indicated action required as a result of the survey by marking either none, retest or repair & retest in Section IX of MDEQ impressed current cathodic protection form.
- Provided UST owner with any other type(s) of documentation that may be necessary in order to adequately describe the cathodic protection evaluation including the operating status and any repairs or recommendations and attached same to the MDEQ impressed current cathodic protection form.

APPENDIX J

TYPICAL POTENTIAL OF SELECTED METALS	
The table below lists some common metals and their observed electrical potentials as measured with respect to a copper/copper sulfate reference electrode.	
METAL	VOLTAGE (mV)
Magnesium (commercially pure)	-1750
Magnesium (alloy found in typical cathodic protection anode)	-1600
Zinc (nearly 100% pure - as found in typical cathodic protection anode)	-1100
Aluminum (5% zinc alloy)	-1050
Aluminum (pure)	-800
Low Carbon Steel (new – clean & shiny)	-600 to -750
Low Carbon Steel (old – rusty)	-500 to -600
Stainless Steel (active - unpassivated)	-450 to -600
Cast Iron (not graphitized)	-500
Lead	-500
Low Carbon Steel in Concrete	-200
Brass, Bronze	-200
Stainless Steel (passivated)	50 to -250
Copper	0 to -200
High Silicone Cast Iron	-200
Carbon, Graphite	+300
Silver	+500
Platinum	+900
Gold	+1200

**APPENDIX K
STATE OF MISSISSIPPI
GALVANIC CATHODIC PROTECTION SYSTEM EVALUATION**

**APPENDIX L
STATE OF MISSISSIPPI
IMPRESSED CURRENT CATHODIC PROTECTION SYSTEM EVALUATION**

**APPENDIX M
STATE OF MISSISSIPPI
IMPRESSED CURRENT CATHODIC PROTECTION SYSTEM
60 DAY RECORD OF OPERATION**

STATE OF MISSISSIPPI

GALVANIC (SACRIFICIAL ANODE) CATHODIC PROTECTION SYSTEM EVALUATION

- This form must be utilized to evaluate underground storage tank (UST) cathodic protection systems in the State of Mississippi.
- Access to the soil directly over the cathodically protected structure that is being evaluated must be provided.
- A site drawing depicting the UST cathodic protection system and all reference electrode placements must be completed.

I. UST OWNER		II. UST FACILITY	
NAME:		NAME:	ID #
ADDRESS:		ADDRESS:	
CITY:	STATE:	CITY:	COUNTY:
III. CP TESTER		IV. CP TESTER'S QUALIFICATIONS	
TESTER'S NAME:		NACE INTERNATIONAL CERTIFICATION NUMBER:	
COMPANY NAME:		MDEQ UST INSTALLER CERTIFICATION NUMBER:	
ADDRESS:		OTHER (EXPLAIN): _____	
CITY:	STATE:		

V. REASON SURVEY WAS CONDUCTED (mark only one)

- Routine - 3 year
 Routine – within 6 months of installation
 90-day re-survey after fail
 Re-survey after repair/modification
- Date next cathodic protection survey must be conducted by _____ (required within 6 months of installation/repair & every 3 years thereafter).

VI. CATHODIC PROTECTION TESTER'S EVALUATION (mark only one)

- PASS** All protected structures at this facility pass the cathodic protection survey and it is judged that adequate cathodic protection has been provided to the UST system (indicate all criteria applicable by completion of Section VIII).
- FAIL** One or more protected structures at this facility fail the cathodic protection survey and it is judged that adequate cathodic protection has not been provided to the UST system (complete Section IX).
- INCONCLUSIVE** If the remote and the local do not both indicate the same test result on all protected structures (both pass or both fail), inconclusive is indicated and the survey must be evaluated and/or conducted by a corrosion expert (complete Section VII).

CP TESTER'S SIGNATURE: _____

DATE CP SURVEY PERFORMED: _____

VII. CORROSION EXPERT'S EVALUATION (mark only one)

The survey must be conducted and/or evaluated by a corrosion expert when: a) an inconclusive is indicated for any protected structure since both the local and the remote structure-to-soil potentials do not result in the same outcome (both pass or both fail); b) repairs to galvanized or uncoated steel piping are conducted or c) supplemental anodes are added to the tanks and/or piping without following an accepted industry code.

- PASS** All protected structures at this facility pass the cathodic protection survey and it is judged that adequate cathodic protection has been provided to the UST system (indicate all criteria applicable by completion of Section VIII).
- FAIL** One or more protected structures at this facility fail the cathodic protection survey and it is judged that adequate cathodic protection has not been provided to the UST system (indicate what action is necessary by completion of Section IX).

CORROSION EXPERT'S NAME: _____

COMPANY NAME: _____

NACE INTERNATIONAL CERTIFICATION: _____

NACE INTERNATIONAL CERTIFICATION NUMBER: _____

CORROSION EXPERT'S SIGNATURE: _____

DATE: _____

VIII. CRITERIA APPLICABLE TO EVALUATION (mark all that apply)

- 850 ON** Structure-to-soil potential more negative than -850 mV with respect to a Cu/CuSO₄ reference electrode with the protective current applied (This criterion is applicable to any galvanically protected structure).
- 850 OFF** Structure-to-soil potential more negative than -850 mV with respect to a Cu/CuSO₄ reference electrode with protective current temporarily interrupted (This criterion is applicable only to those galvanic systems where the anodes can be disconnected).
- 100 mV POLARIZATION** Structure tested exhibits at least 100 mV of cathodic polarization (This criterion is applicable to galvanic systems where the anodes can be temporarily disconnected).

IX. ACTION REQUIRED AS A RESULT OF THIS EVALUATION (mark only one)

- NONE** Cathodic protection is adequate. No further action is necessary at this time. Test again by no later than (see Section V).
- RETEST** Cathodic protection may not be adequate. Retest during the next 90 days to determine if passing results can be achieved.
- REPAIR & RETEST** Cathodic protection is not adequate. Repair/modification is necessary as soon as practical but within the next 90 days.

X. DESCRIPTION OF UST SYSTEM

TANK #	PRODUCT	CAPACITY	TANKS	PIPING	FLEX CONNECTORS
1					
2					
3					
4					
5					
6					
7					
8					
9					
10					

XI. DESCRIPTION OF CATHODIC PROTECTION SYSTEM REPAIRS AND/OR MODIFICATION

Complete if any repairs or modifications to the cathodic protection system are made or are necessary. Certain repairs/modifications as explained in the text of the MDEQ cathodic protection guidance document are required to be designed and/or evaluated by a corrosion expert (completion of Section VII required).

- Supplemental anodes for a sti-P₃[®] tank (attach corrosion expert's design or documentation industry standard was followed).
- Supplemental anodes for metallic pipe (attach corrosion expert's design or documentation industry standard was followed).
- Galvanically protected tanks/piping not electrically isolated (explain in "Remarks/Other" below).

Remarks/Other: _____

XII. UST FACILITY SITE DRAWING

Attach detailed drawing or use the space provided to draw a sketch of the UST and cathodic protection systems. Sufficient detail must be given in order to clearly indicate where the reference electrode was placed for each structure-to-soil potential that is recorded on the survey forms. Any pertinent data must also be included. At a minimum you should indicate the following: All tanks, piping and dispensers; All buildings and streets; All anodes and wires; Location of CP test stations; Each reference electrode placement must be indicated by a code (1,2, T-1,) corresponding with the appropriate line number in Section XIV of this form.

AN EVALUATION OF THE CATHODIC PROTECTION SYSTEM IS NOT COMPLETE WITHOUT AN ACCEPTABLE SITE DRAWING.

XIII. GALVANIC (SACRIFICIAL ANODE) CATHODIC PROTECTION SYSTEM CONTINUITY SURVEY

- This section may be utilized to conduct measurements of continuity on underground storage tank systems that are protected by cathodic protection systems.
- When conducting a fixed cell - moving ground survey, the reference electrode must be placed in the soil at a remote location and left undisturbed.
- Conduct point-to-point test between any two structures for which the fixed cell-moving ground survey is inconclusive or indicates possible continuity.
- For galvanic systems, the structure that is to be protected must be isolated from any other metallic structure in order to pass the continuity survey.

FACILITY NAME:

NOTE: The survey is not complete unless all applicable parts of Sections I-XIV are also completed

DESCRIBE LOCATION OF "FIXED REMOTE" REFERENCE ELECTRODE PLACEMENT:

STRUCTURE "A" ¹	STRUCTURE "B" ²	STRUCTURE "A" ³ FIXED REMOTE VOLTAGE	STRUCTURE "B" ⁴ FIXED REMOTE VOLTAGE	POINT-TO-POINT ⁵ VOLTAGE DIFFERENCE	ISOLATED/ ⁶ CONTINUOUS/ INCONCLUSIVE
(example) PREMIUM TANK BOTTOM	(example) PREMIUM TANK FILL RISER	(example) -921 mV	(example) -915 mV		(example) INCONCLUSIVE
(example) PREMIUM TANK BOTTOM	(example) PREMIUM TANK FILL RISER			(example) 17 mV	(example) ISOLATED

COMMENTS:

1 Describe the cathodically protected structure that you are attempting to demonstrate is isolated from unprotected structures (e.g. prem. tank).
 2 Describe the unprotected structure that you are attempting to demonstrate is isolated from the protected structure (e.g. premium tank fill riser).
 3 Record the measured structure-to-soil potential of the cathodically protected structure {"A"} in millivolts (e.g. -921 mV).
 4 Record the measured structure-to-soil potential of the unprotected structure {"B"} in millivolts (e.g. -915 mV).
 5 Record the voltage observed between the protected and the unprotected structures when conducting point-to-point testing (e.g. 17 mV).
 6 Document whether the test (fixed cell and/or point to point) indicated the protected structure was isolated, continuous or inconclusive.

XIV. GALVANIC (SACRIFICIAL ANODE) CATHODIC PROTECTION SYSTEM SURVEY

- > This section may be utilized to conduct a survey of a galvanic cathodic protection system by obtaining structure-to-soil potential measurements.
- > The reference electrode must be placed in the soil directly over the tested structure (local) **and** 25-100 feet away from the structure (remote).
- > Both the local and the remote voltage must be -850 mV or more negative, in order for the structure to pass.
- > Inconclusive is indicated when both the local and the remote structure-to-soil potentials do not result in the same outcome (both pass or both fail).

FACILITY NAME:

NOTE: The survey is not complete unless all applicable parts of sections I – XIV are also completed

DESCRIBE LOCATION OF REMOTE REFERENCE ELECTRODE PLACEMENT:

LOCATION CODE¹	STRUCTURE²	CONTACT POINT³	LOCAL REFERENCE CELL PLACEMENT⁴	LOCAL VOLTAGE⁵	REMOTE VOLTAGE⁶	PASS/FAIL/⁷ INCONCLUSIVE
(example) 1	(example) PLUS TANK	(example) TANK BOTTOM	(example) PLUS TANK STP MANWAY	(example) -928	(example) -810	(example) INCONCLUSIVE
(example) 2	(example) PLUS PIPING	(example) DISPENSER 5/6	(example) UNDER DISPENSER 5/6	(example) -890	(example) -885	(example) PASS

COMMENTS:

- 1 Designate numerically or by code on the site drawing each “local” reference electrode placement (e.g. 1,2,3... T-1, T-2, P-1, P-2...etc.).
- 2 Describe the structure that is being tested (e.g. plus tank; premium piping; diesel submersible pump flex connector; etc.).
- 3 Describe where contact with the structure that is being tested is made (e.g. plus tank @ test lead; diesel piping @ dispenser 5/6; tank test lead; pp4, etc).
- 4 Describe the exact location where reference electrode is placed for each “local” measurement (e.g. soil @ plus tank STP; soil @ dispenser 5/6; etc.)
- 5 Record the structure-to-soil potential measured with the reference electrode placed “local” in millivolts (e.g. -865 mV, -920 mV, etc.).
- 6 Record the structure-to-soil potential measured with the reference electrode placed “remote” (copy voltage that was obtained during continuity survey).
- 7 Indicate whether the tested structure passed or failed the -850 mV “on” criterion based on your interpretation of the test data.

STATE OF MISSISSIPPI

IMPRESSED CURRENT CATHODIC PROTECTION SYSTEM EVALUATION

- This form must be utilized to evaluate underground storage tank (UST) cathodic protection systems in the State of Mississippi.
- Access to the soil directly over the cathodically protected structure that is being evaluated must be provided.
- A site drawing depicting the UST cathodic protection system and all reference electrode placements must be completed.

I. UST OWNER		II. UST FACILITY	
NAME:		NAME:	ID #
ADDRESS:		ADDRESS:	
CITY:	STATE:	CITY:	COUNTY:
III. CP TESTER		IV. CP TESTER'S QUALIFICATIONS	
TESTER'S NAME:		NACE INTERNATIONAL CERTIFICATION NUMBER:	
COMPANY NAME:		MDEQ UST INSTALLER CERTIFICATION NUMBER:	
ADDRESS:		OTHER (EXPLAIN): _____	
CITY:	STATE:		

V. REASON SURVEY WAS CONDUCTED (mark only one)

- Routine - 3 year
 Routine – within 6 months of installation
 90-day re-survey after fail
 Re-survey after repair/modification
- Date next cathodic protection survey must be conducted _____ (required within 6 months of installation/repair & every 3 years thereafter).

VI. CATHODIC PROTECTION TESTER'S EVALUATION (mark only one)

- PASS** All protected structures at this facility pass the cathodic protection survey and it is judged that adequate cathodic protection has been provided to the UST system (indicate all criteria applicable by completion of Section VIII).
- FAIL** One or more protected structures at this facility fail the cathodic protection survey and it is judged that adequate cathodic protection has not been provided to the UST system (complete Section IX).
- INCONCLUSIVE** The cathodic protection survey of an impressed current system must be evaluated by a corrosion expert because one or more of the conditions listed in Section 7.1.5 of the MDEQ cathodic protection guidance document are applicable (complete Section VII).

CP TESTER'S SIGNATURE:

DATE CP SURVEY PERFORMED:

VII. CORROSION EXPERT'S EVALUATION (mark only one)

The survey must be conducted and/or evaluated by a corrosion expert when: a) supplemental anodes or other changes in the construction of the impressed current system are made; b) stray current may be affecting buried metallic structures or c) an inconclusive result was indicated in Section VI.

- PASS** All protected structures at this facility pass the cathodic protection survey and it is judged that adequate cathodic protection has been provided to the UST system (indicate all criteria applicable by completion of Section VIII).
- FAIL** One or more protected structures at this facility fail the cathodic protection survey and it is judged that adequate cathodic protection has not been provided to the UST system (indicate what action is necessary by completion of Section IX).

CORROSION EXPERT'S NAME:

COMPANY NAME:

NACE INTERNATIONAL CERTIFICATION:

NACE INTERNATIONAL CERTIFICATION NUMBER:

CORROSION EXPERT'S SIGNATURE:

DATE:

VIII. CRITERIA APPLICABLE TO EVALUATION (mark all that apply)

- 850 OFF** Structure-to-soil potential more negative than -850 mV with respect to a Cu/CuSO₄ reference electrode with protective current temporarily interrupted (instant-off).
- 100 mV POLARIZATION** Structure(s) exhibit at least 100 mV of cathodic polarization.

IX. ACTION REQUIRED AS A RESULT OF THIS EVALUATION (mark only one)

- NONE** Cathodic protection is adequate. No further action is necessary at this time. Test again by no later than (see Section V).
- RETEST** Cathodic protection may not be adequate. Retest during the next 90 days to determine if passing results can be achieved.
- REPAIR & RETEST** Cathodic protection is not adequate. Repair/modification is necessary as soon as practical but within the next 90 days.

X. DESCRIPTION OF UST SYSTEM

TANK #	PRODUCT	CAPACITY	TANK MATERIAL	PIPING MATERIAL	FLEX CONNECTORS
1					
2					
3					
4					
5					
6					
7					
8					
9					
10					

XI. IMPRESSED CURRENT RECTIFIER DATA (complete all applicable)

In order to conduct an effective evaluation of the cathodic protection system, a complete evaluation of rectifier operation is necessary.

RECTIFIER MANUFACTURER:	RATED DC OUTPUT: _____ VOLTS _____ AMPS
RECTIFIER MODEL:	RECTIFIER SERIAL NUMBER:

RECTIFIER OUTPUT AS INITIALLY DESIGNED OR LASTLY RECOMMENDED (if available): _____ VOLTS _____ AMPS

EVENT	DATE	TAP SETTINGS		DC OUTPUT		HOUR METER	COMMENTS
		COARSE	FINE	VOLTS	AMPS		
"AS FOUND"							
"AS LEFT"							

XII. IMPRESSED CURRENT POSITIVE & NEGATIVE CIRCUIT MEASUREMENTS (output amperage)

Complete if the system is designed to allow such measurements (i.e. individual lead wires for each anode are installed and measurement shunts are present).

CIRCUIT	1	2	3	4	5	6	7	8	9	10	TOTAL
ANODE (+)											
TANK (-)											

XIII. DESCRIPTION OF CATHODIC PROTECTION SYSTEM REPAIRS AND/OR MODIFICATION

Complete if any repairs or modifications to the cathodic protection system are made OR are necessary. Certain repairs/modifications as explained in the text of the MDEQ cathodic protection guidance document are required to be designed and/or evaluated by a corrosion expert (completion of Section VII required).

- Additional anodes for an impressed current system (attach corrosion expert's design).
- Repairs or replacement of rectifier (explain in "Remarks/Other" below).
- Anode header cables repaired and/or replaced(explain in "Remarks/Other" below).
- Impressed current protected tanks/piping not electrically continuous (explain in "Remarks/Other" below).

Remarks/Other: _____

XIV. UST FACILITY SITE DRAWING

Attach detailed drawing of the UST and cathodic protection systems. Sufficient detail must be given in order to clearly indicate where the reference electrode was placed for each structure-to-soil potential that is recorded on the survey forms. Any pertinent data must also be included. At a minimum you should indicate the following: All tanks, piping and dispensers; All buildings and streets; All anodes and wires; Location of CP test stations; Each reference electrode placement must be indicated by a code (1,2,3 R-1, R-2, R-3...etc.) corresponding with the appropriate line number in Section XVI of this form.

AN EVALUATION OF THE CATHODIC PROTECTION SYSTEM IS NOT COMPLETE WITHOUT AN ACCEPTABLE SITE DRAWING.

XV. IMPRESSED CURRENT CATHODIC PROTECTION SYSTEM CONTINUITY SURVEY

- This section may be utilized to conduct measurements of continuity on underground storage tank systems that are protected by cathodic protection systems.
- When conducting a fixed cell - moving ground survey, the reference electrode must be placed in the soil at a remote location and left undisturbed.
- Conduct point-to-point test between any two structures for which the fixed cell - moving ground survey is inconclusive or indicates possible isolation.
- For impressed current systems, the protected structure must be continuous with all other protected structures in order to pass the continuity survey.

FACILITY NAME:

NOTE: The survey is not complete unless all applicable parts of sections I-XIV are also completed

DESCRIBE LOCATION OF "FIXED REMOTE" REFERENCE ELECTRODE PLACEMENT:

STRUCTURE "A" ¹	STRUCTURE "B" ²	STRUCTURE "A" ³ FIXED REMOTE INSTANT OFF VOLTAGE	STRUCTURE "B" ⁴ FIXED REMOTE INSTANT OFF VOLTAGE	POINT-TO-POINT ⁵ VOLTAGE DIFFERENCE	ISOLATED/ CONTINUOUS/ INCONCLUSIVE ⁶
(example) PLUS TANK BOTTOM	(example) PLUS STEEL PRODUCT LINE @ STP	(example) -915 mV	(example) -908 mV		(example) INCONCLUSIVE
(example) PLUS TANK BOTTOM	(example) PLUS STEEL PRODUCT LINE @ STP			(example) 1 mV	(example) CONTINUOUS

1 Describe the protected structure {"A"} that you are attempting to demonstrate is continuous (e.g. plus tank bottom).
 2 Describe the "other" protected structure {"B"} that you are attempting to demonstrate is continuous (e.g. plus steel product line @ STP).
 3 Record the fixed remote instant off structure-to-soil potential of the protected structure {"A"} in millivolts (e.g. -915 mV).
 4 Record the fixed remote instant off structure-to-soil potential of the "other" protected structure {"B"} in millivolts (e.g. -908 mV).
 5 Record the voltage difference observed between structure "A" and structure "B" when conducting "point-to-point" testing (e.g. 1mV).
 6 Document whether the test (fixed cell and/or point to point) indicated the protected structure was isolated, continuous or inconclusive.

XVI. IMPRESSED CURRENT CATHODIC PROTECTION SYSTEM SURVEY

- This section may be utilized to conduct a survey of an impressed current cathodic protection system by obtaining structure-to-soil potential measurements.
- The reference electrode must be placed in the soil directly above the structure that is being tested and as far away from any active anode as practical to obtain a valid structure-to-soil potential (refer to the MDEQ cathodic protection evaluation guidance document for detailed discussion of electrode placement).
- Both on and instant off potentials must be measured for each structure that is intended to be under cathodic protection.
- The instant off potential must be -850 mV or more negative or the 100 mV polarization criterion must be satisfied in order to pass.

FACILITY NAME: _____ NOTE: This survey is not complete unless all applicable parts of sections I – XIV are also completed

LOCATION CODE ¹	STRUCTURE ²	CONTACT POINT ³	REFERENCE CELL PLACEMENT ⁴	ON ⁵ VOLTAGE	INSTANT OFF VOLTAGE ⁶	100 mV POLARIZATION		PASS/ FAIL ⁹
						ENDING ⁷ VOLTAGE	VOLTAGE ⁸ CHANGE	
(example) 1	(example) PLUS TANK	(example) TANK BOTTOM	(example) SOIL @ REG. TANK STP MANWAY	(example) -1070mV	(example) -875 mV	(example)	(example)	(example) PASS
(example) 2	(example) DIESEL PIPE	(example) DISPENSER 7/8	(example) SOIL @ DIESEL TANK STP MANWAY	(example) -810 mV	(example) -680 mV	(example) -575 mV	(example) 105 mV	(example) PASS

COMMENTS:

1 Designate numerically or by code on the site drawing each local reference electrode placement (e.g. 1,2,3... T-1, T-2, P-1, P-2...etc.).
 2 Describe the structure that is being tested (e.g. plus tank; diesel piping; flex connector, etc.).
 3 Describe where the structure being tested is contacted by the test lead (e.g. plus tank bottom; diesel piping @ dispenser 7/8; etc.).
 4 Describe the exact location where the reference electrode is placed for each measurement (e.g. soil @ regular tank STP manway; soil @ dispenser 2, etc.)
 5 {Applies to all tests} Record the structure-to-soil potential (voltage) observed with the current applied (e.g. -1070 mV).
 6 {Applies to all tests} Record the structure to soil potential (voltage) observed when the current is interrupted (e.g. 680 mV).
 7 {Applies to 100 mV polarization test only} Record the voltage observed at the end of the test period (e.g. 575 mV).
 8 {Applies to 100 mV polarization test only} Subtract the final voltage from the instant off voltage (e.g. 680 mV – 575 mV = 105 mV).
 9 Indicate if the tested structure passed or failed one of the two acceptable criteria (850 instant off or 100 mV polarization) based on your interpretation of data.

**STATE OF MISSISSIPPI
 IMPRESSED CURRENT CATHODIC PROTECTION SYSTEM
 60-DAY RECORD OF RECTIFIER OPERATION**

- > This form may be utilized to document that the cathodic protection system rectifier is checked for operation at least once every 60 days.
- > Checked for operation is taken to mean that it was confirmed the rectifier was receiving power and is "turned-on".
- > If your rectifier is so equipped, you should also record the output voltage, amperage and the number of hours indicated on the meter.
- > Any significant variance should be reported to your corrosion professional so that any repairs and/or adjustments necessary can be made.

UST OWNER			UST FACILITY		
NAME:			NAME:		ID #
ADDRESS:			ADDRESS:		
CITY:		STATE:	CITY:		COUNTY:

IMPRESSED CURRENT RECTIFIER DATA

Rectifier Manufacturer:	Rated DC Output: _____ VOLTS _____ AMPS
Rectifier Model:	Rectifier Serial Number:
What is the 'as designed' or lastly recommended rectifier output? _____ VOLTS _____ AMPS	

60-DAY LOG OF RECTIFIER OPERATION

DATE INSPECTED	RECTIFIER TURNED ON?	TAP SETTINGS		DC OUTPUT		HOUR METER	INSPECTOR INITIALS	COMMENTS
		COARSE	FINE	VOLTS	AMPS			